

ASSENSHEMA

MEETPUNT	X	Y
1	134712.644	518615.924
8	134413.131	518348.292
9	134780.268	518544.867
9A	134781.842	518541.968
10	134815.152	518484.446
11	134779.905	518464.096
12	134849.770	518343.087
13	134731.431	518274.754
14	134741.878	518256.670
15	134731.472	518232.765
16	134602.584	518100.374
17	134524.551	518221.282
18	134495.683	518204.787

RENVOL

MATEN IN MM  
 1:00  
 BESTAANDE MAASVELD HOOGTE TOV NAP IN METERS  
 KADERMUUR MET HOOGTE TOV NAP  
 KADERMUUR MET HOEK  
 DAPWAND MET BETONSLOOF  
 SONDERING  
 BORING  
 SLOIEN OPSCHONEN EN DEMPEN MET GROND  
 GRONDOENVULLING ALTERN KADERMUUR  
 MET ZAND TE DEMPEN SLOOT  
 TE HANDHAVEN (BOMEN)  
 TE ROOIJEN (BOMEN)  
 REGENUITLAAT  
 DRILDOPLIJDING PVL 400 KLASSE 34  
 LAVABANK  
 ONTSLUITING LAVABANK

Behoort bij de...  
 de stad/burgemeester en wethouders  
 der gemeente Hoorn dd 6.9.83 no 362.03  
 Mij bekend.  
 de gemeente secretaris  
 van Hoorn

INGEKOMEN  
 11 JULI 1983  
 BUREAU WOON- EN  
 BOUW- EN  
 VERKEER  
 GEZINS- EN  
 VERKEER  
 14 JULI 1983  
 GEZIEN

19830362

NO	WIJZIGING	DATUM	NAAM		
OPDRACHTGEVER: GEMEENTE HOORN					
PROJEKT: KADERMUREN KIRSENBOOGGERD ZUID					
ONDERDEEL: <b>SITUATIE</b>					
GET	DATUM	NAAM	GET	DATUM	NAAM
019783		GEK	319783	GEZ	
INGENIEURSBUREAU: <b>GRABOWSKY &amp; POORT B.V.</b>					
FORMAAT: 1345 x 678		KANTOOR-HOORN: BREED 11		SCHAAL: 1:500	
		1821 KA HOORN, TEL. 02290-18241		4777 1 0	

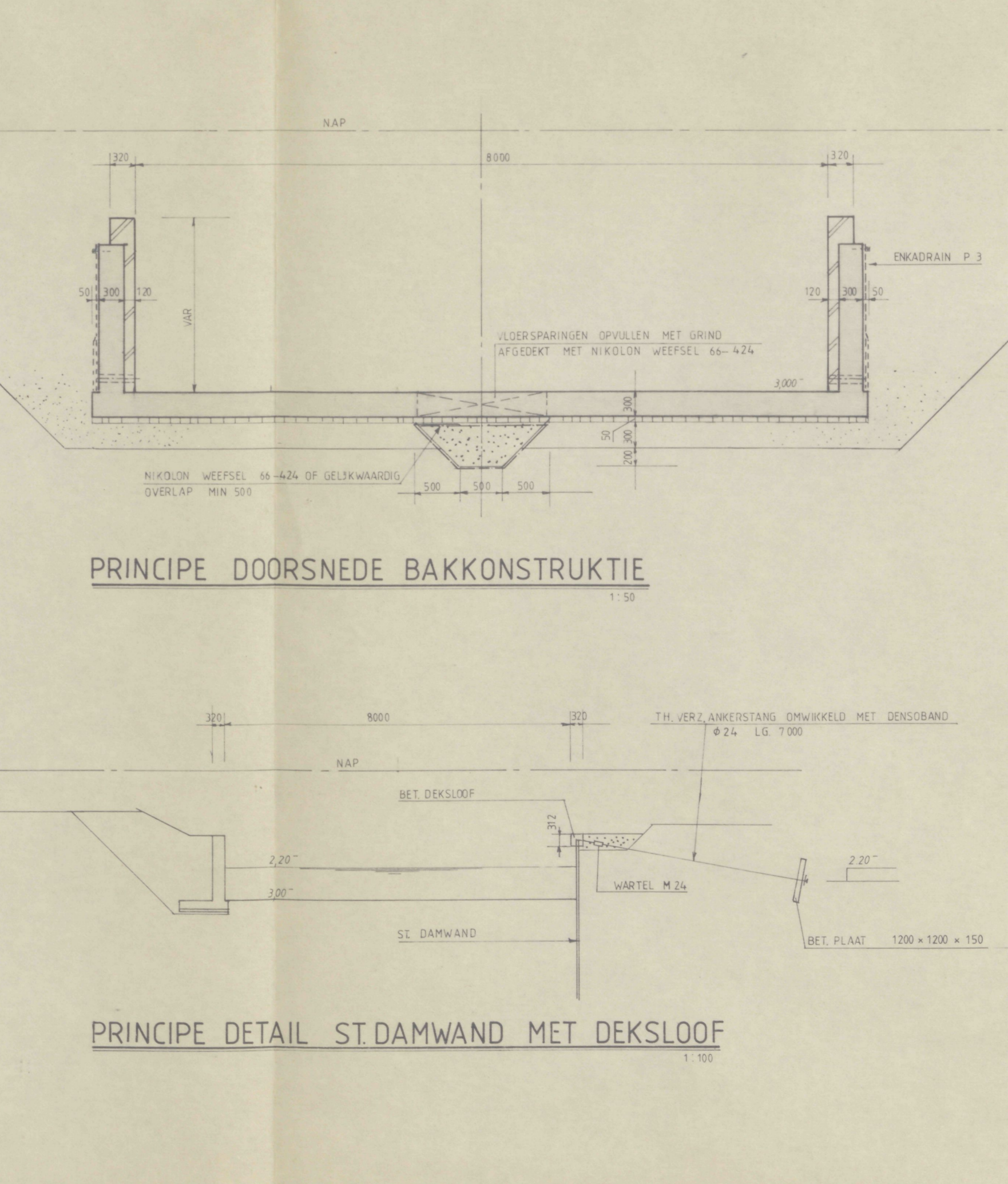
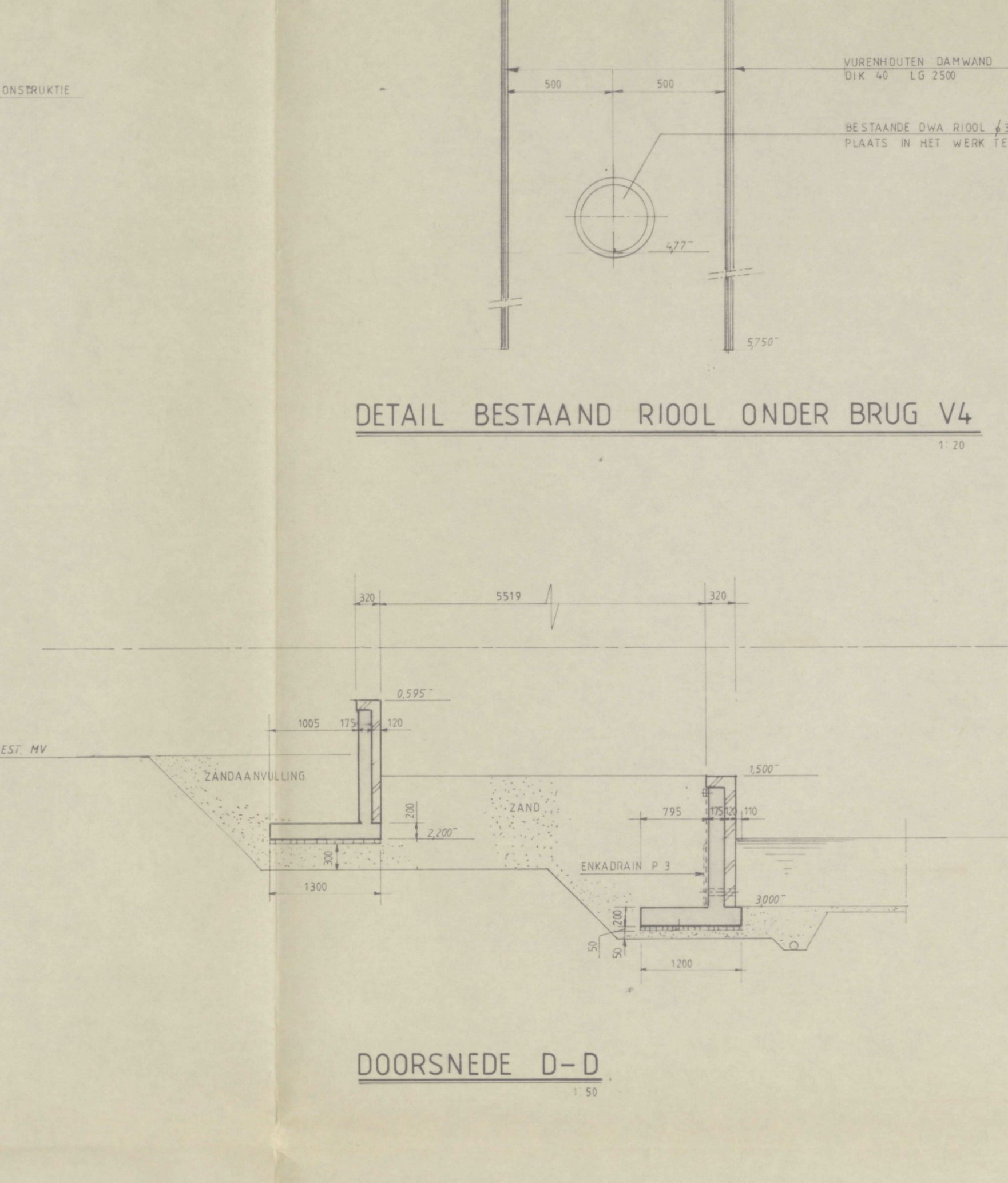
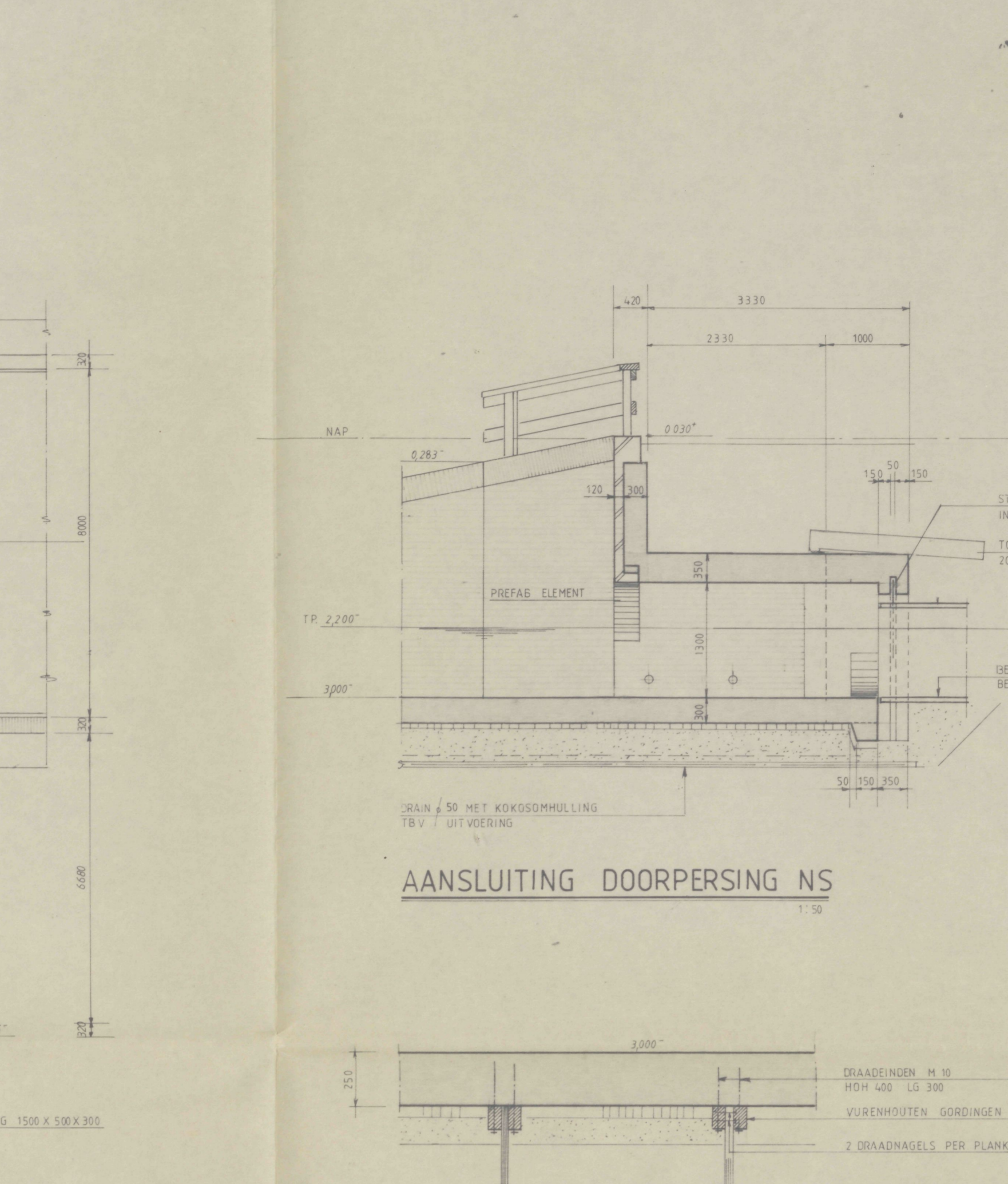
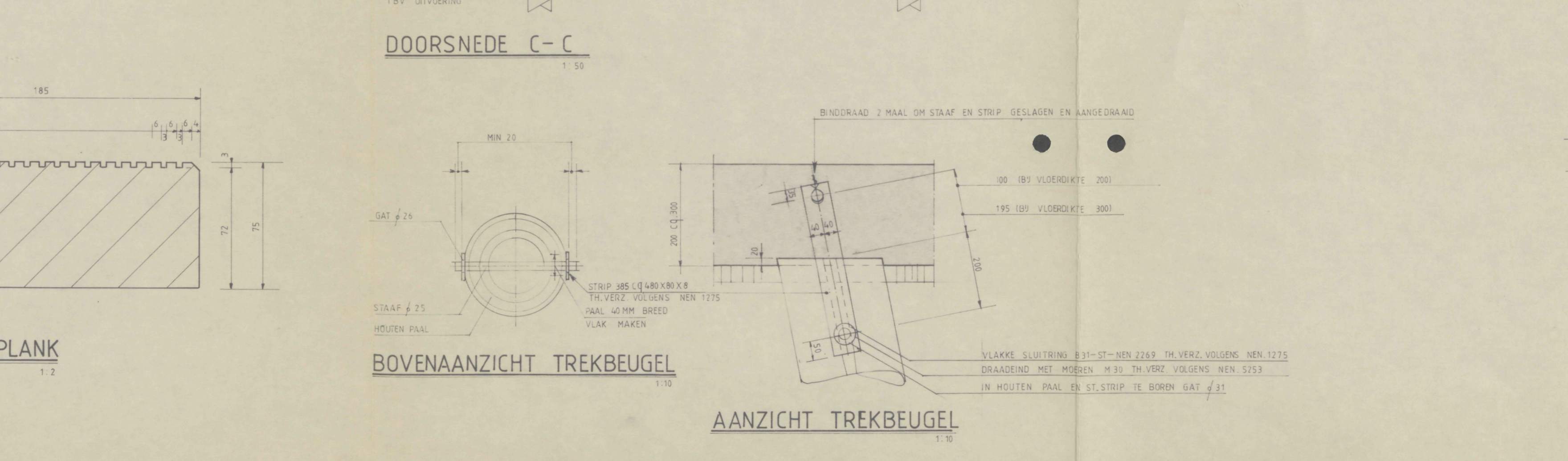
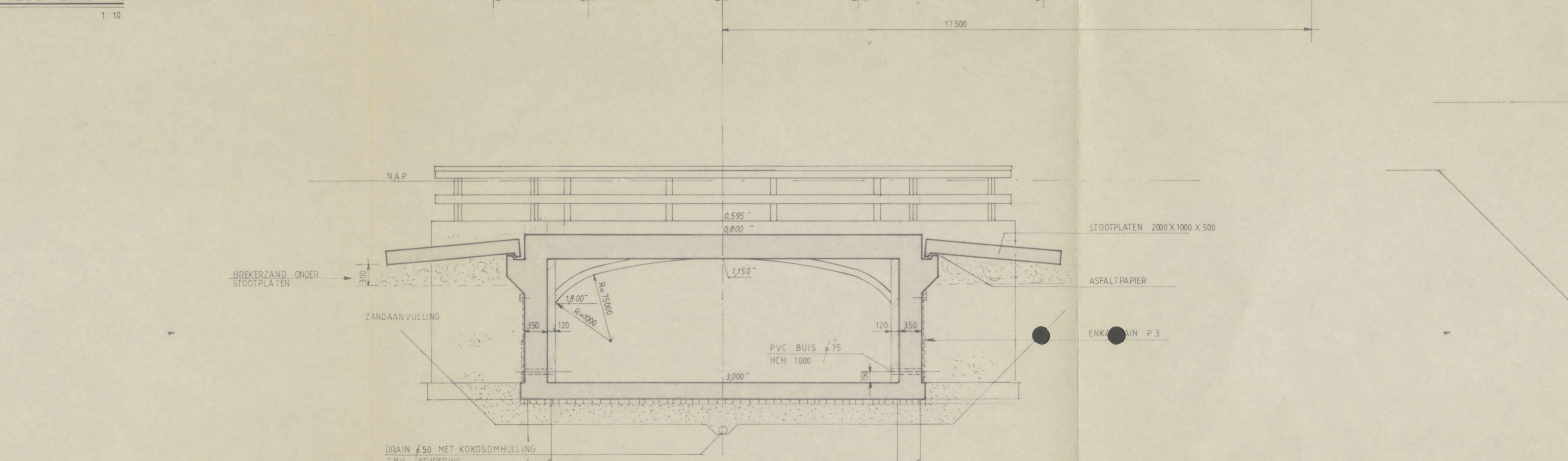
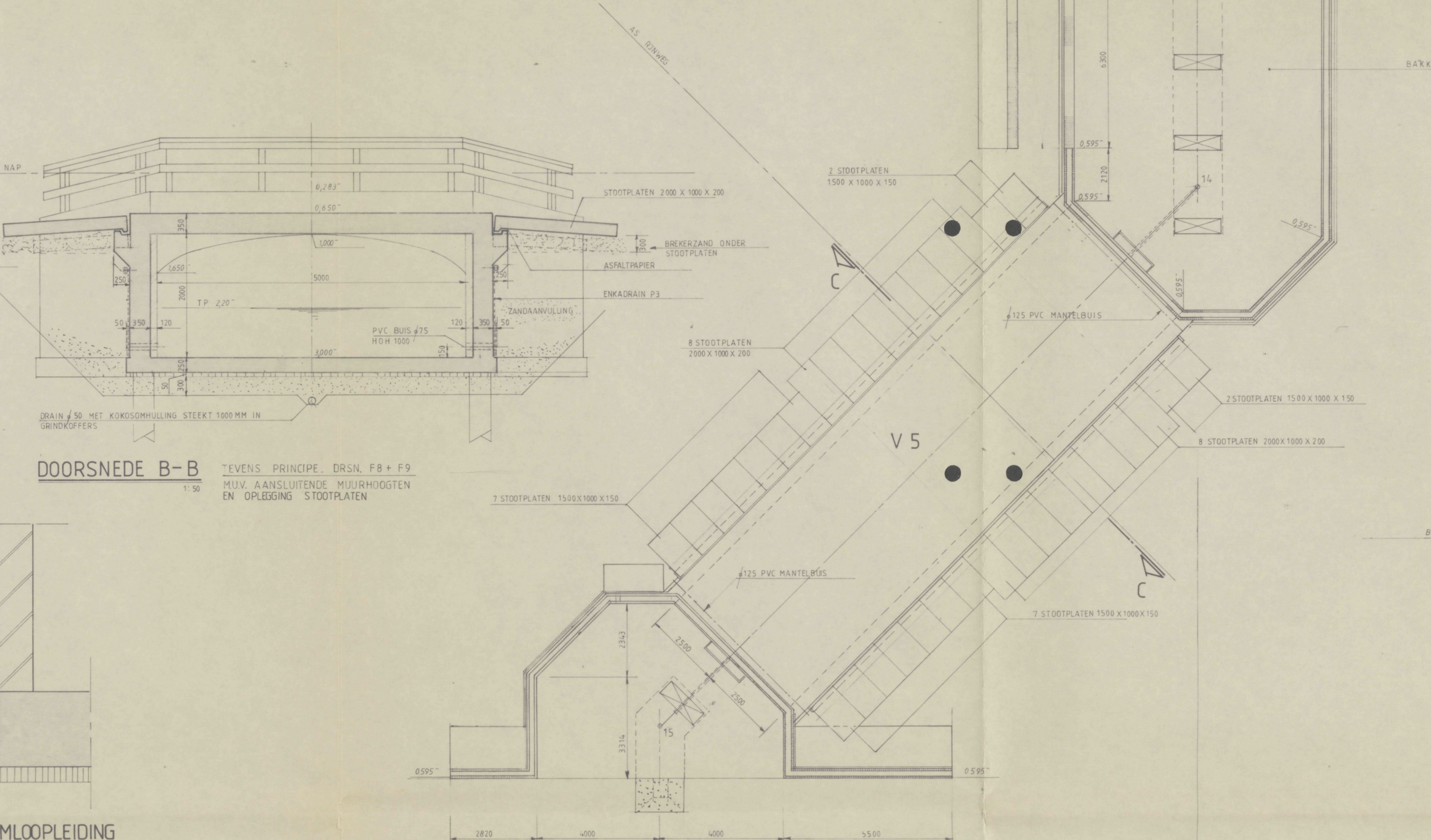
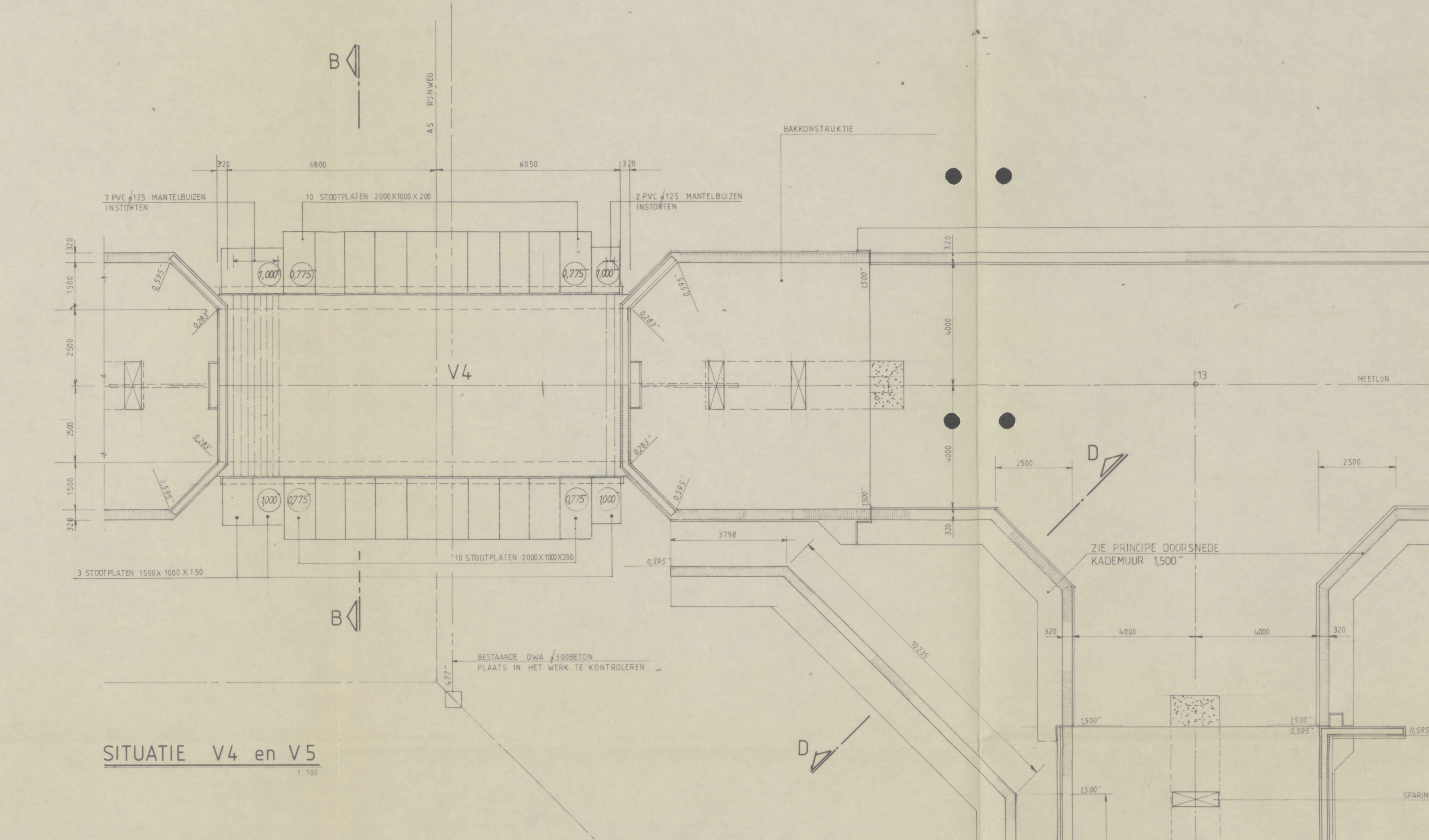
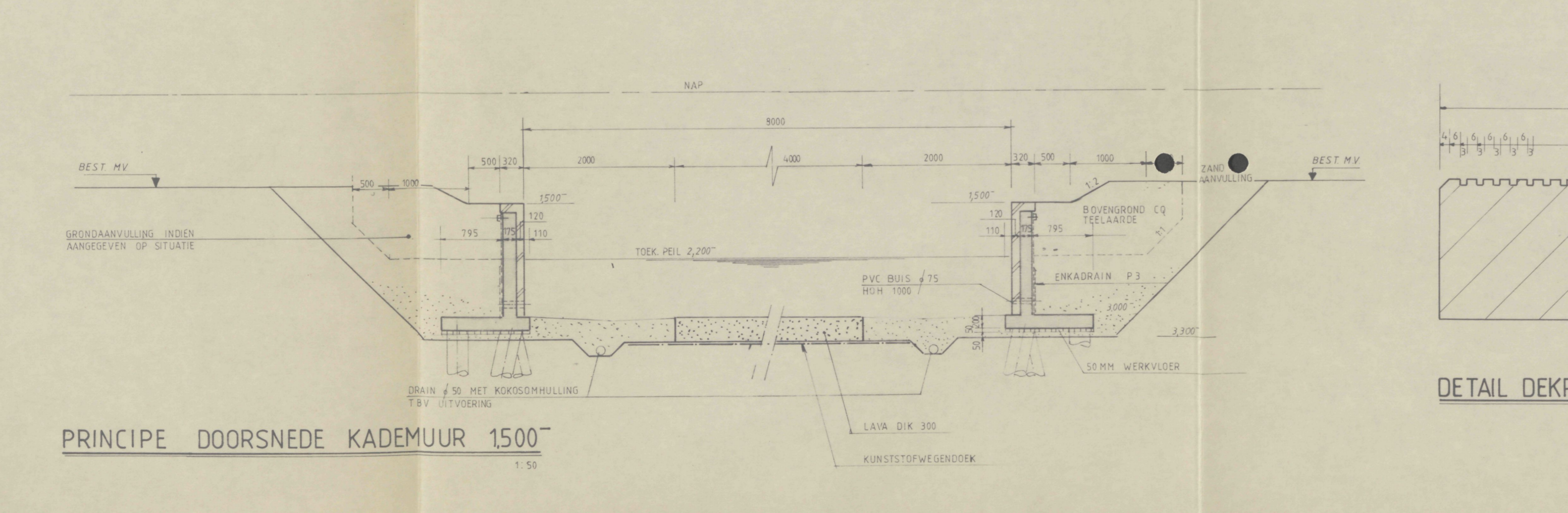
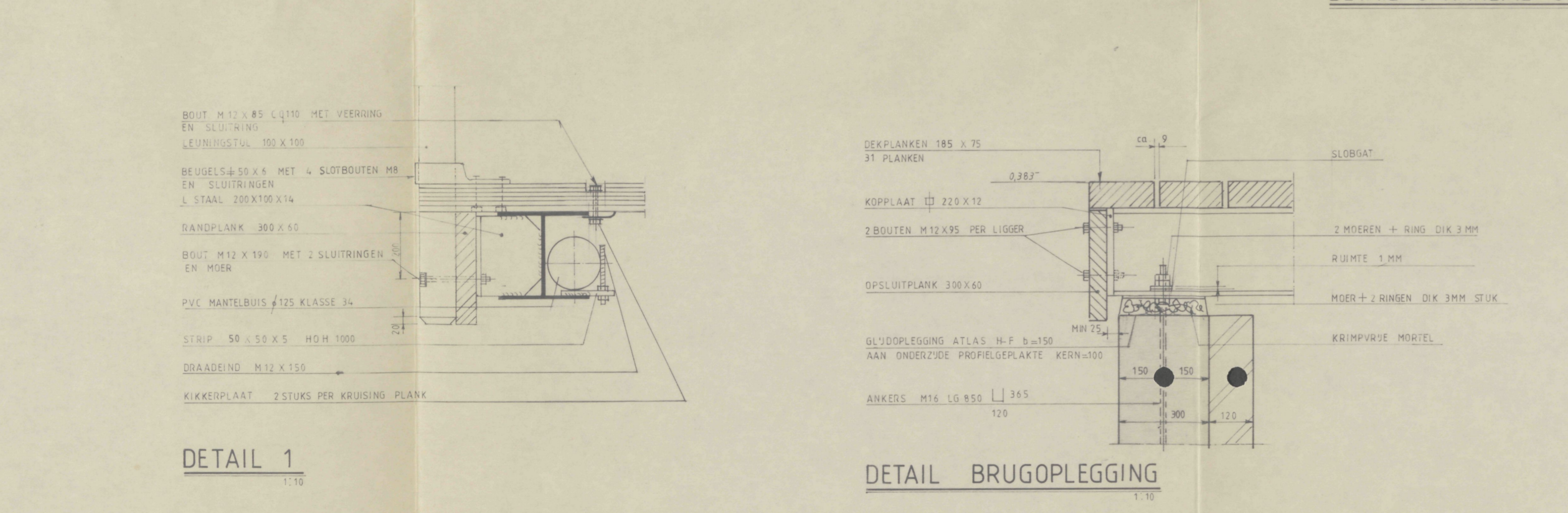
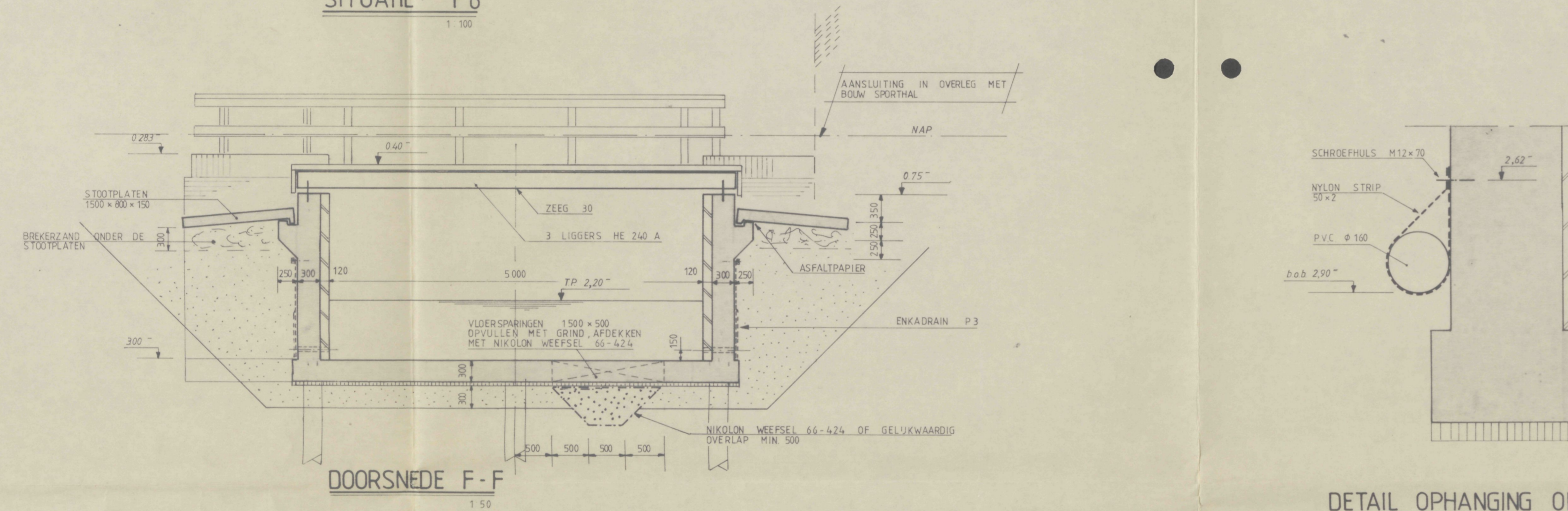
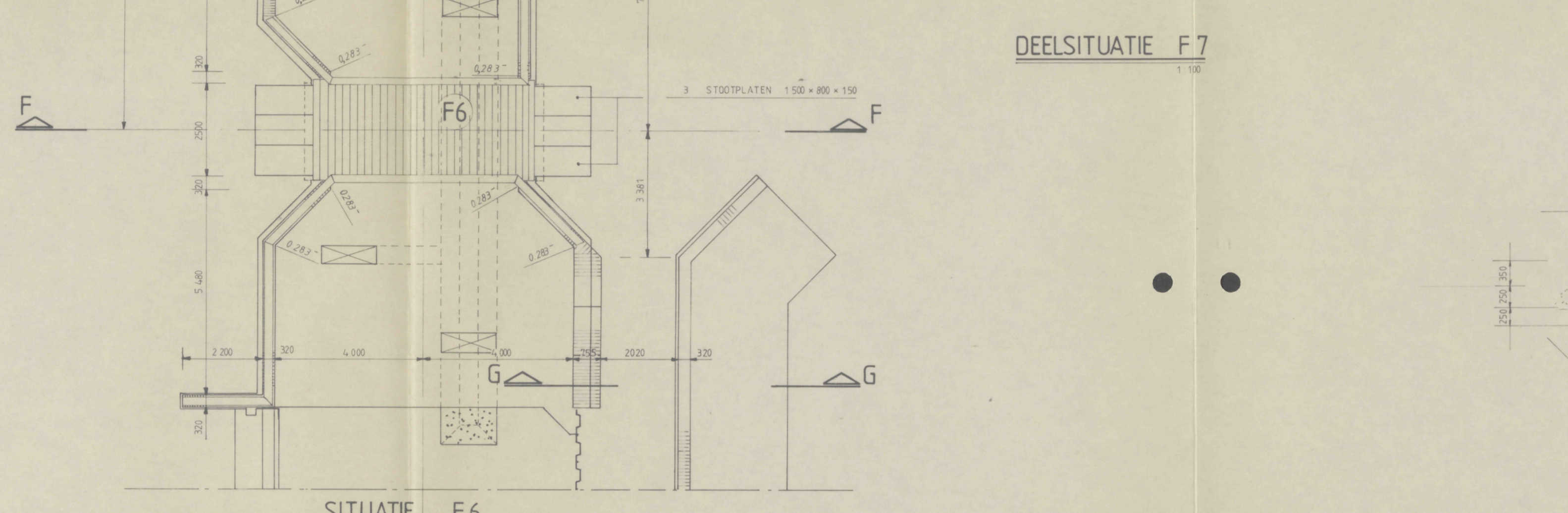
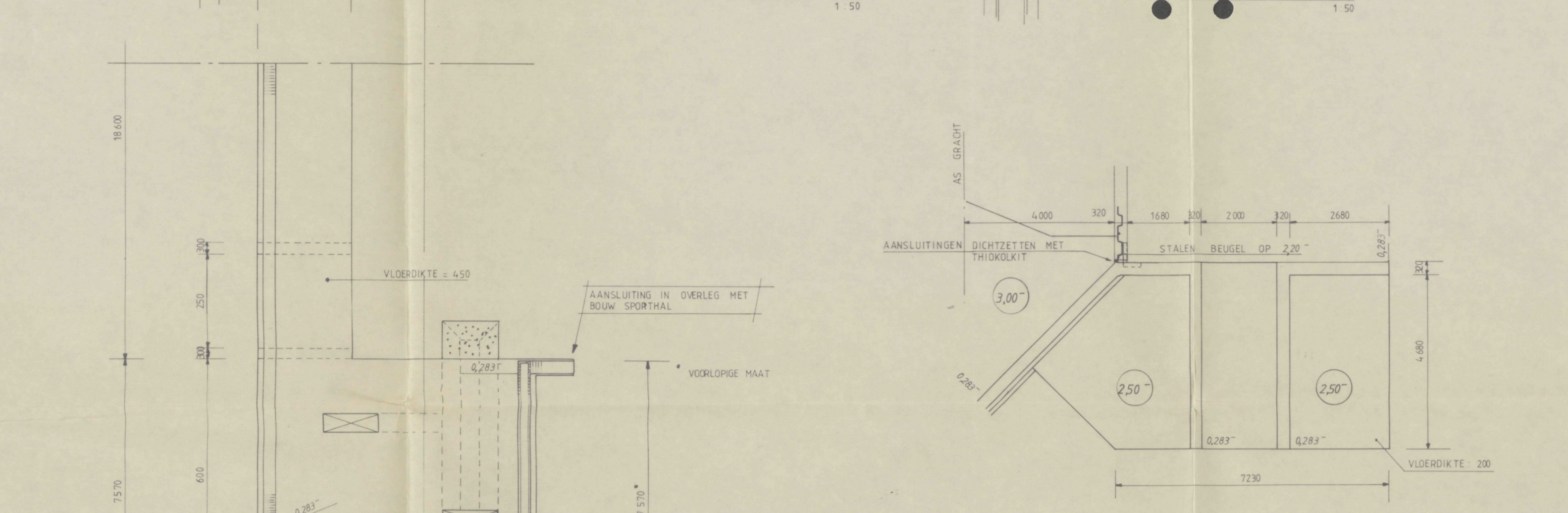
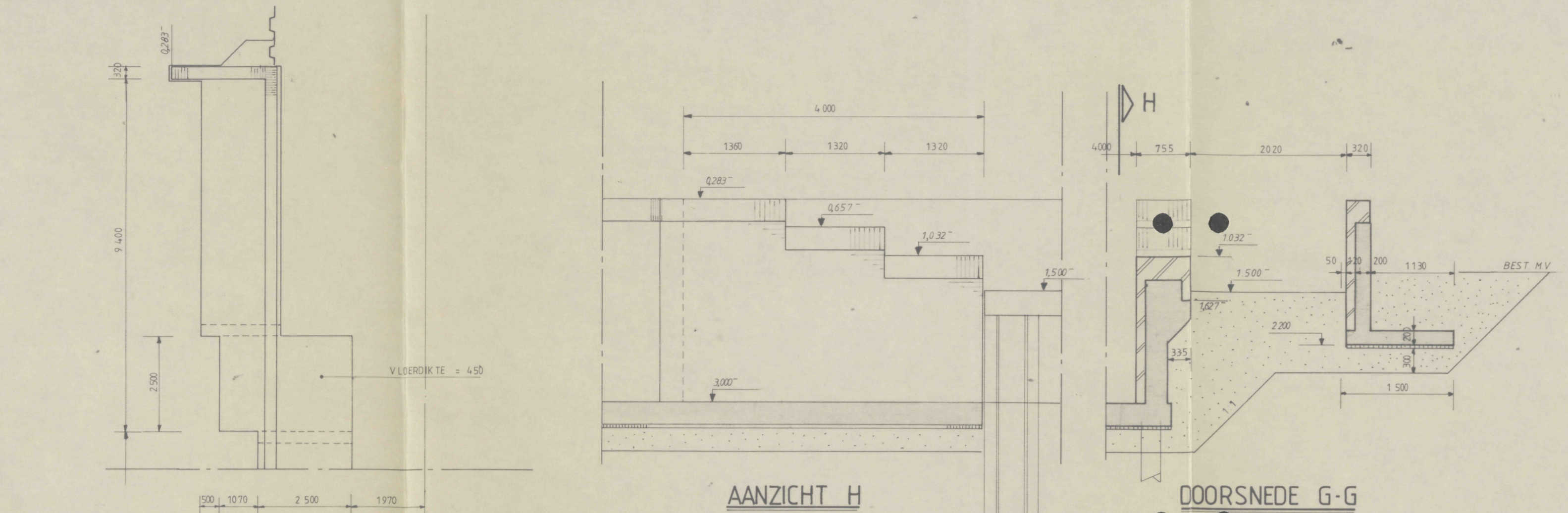

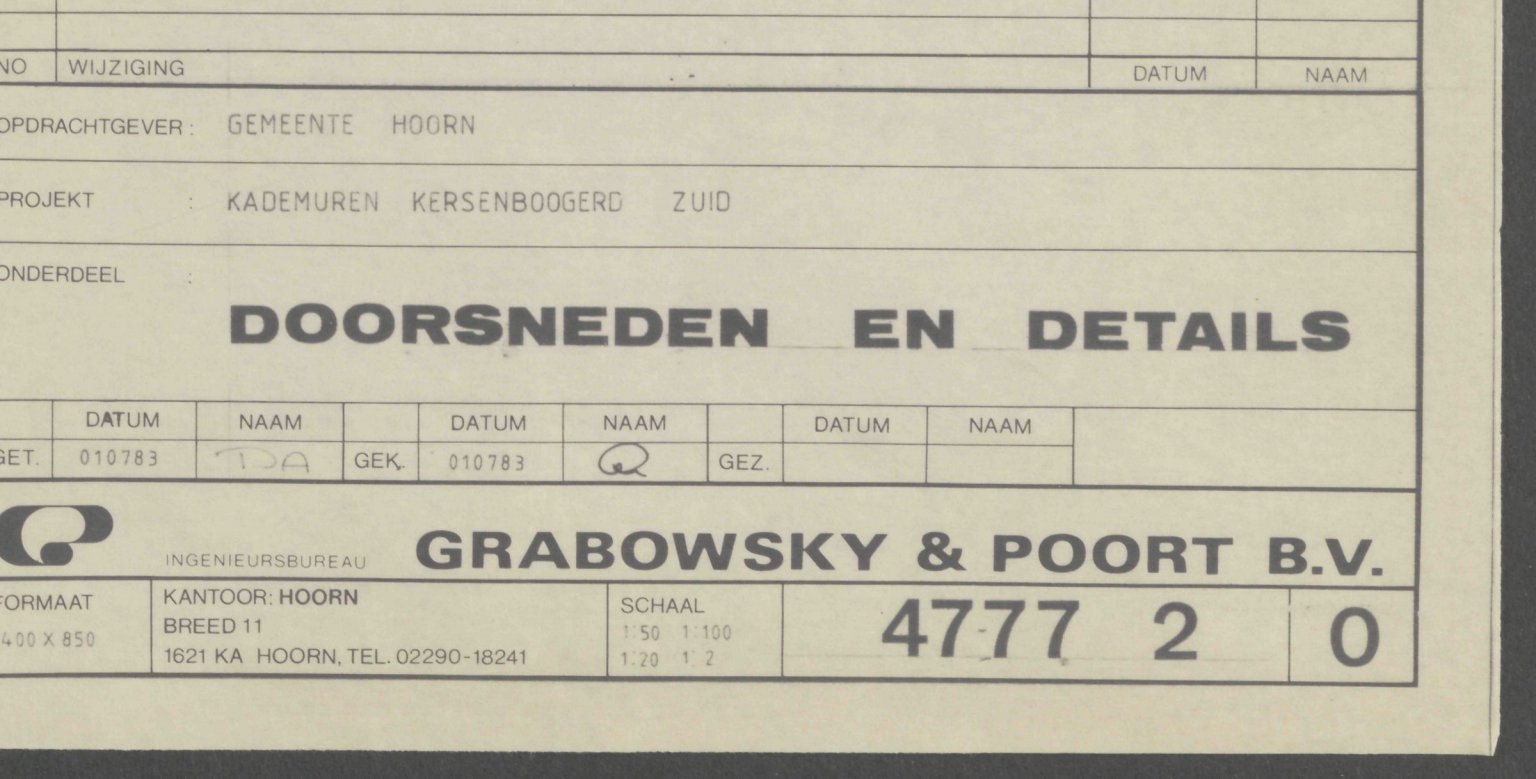
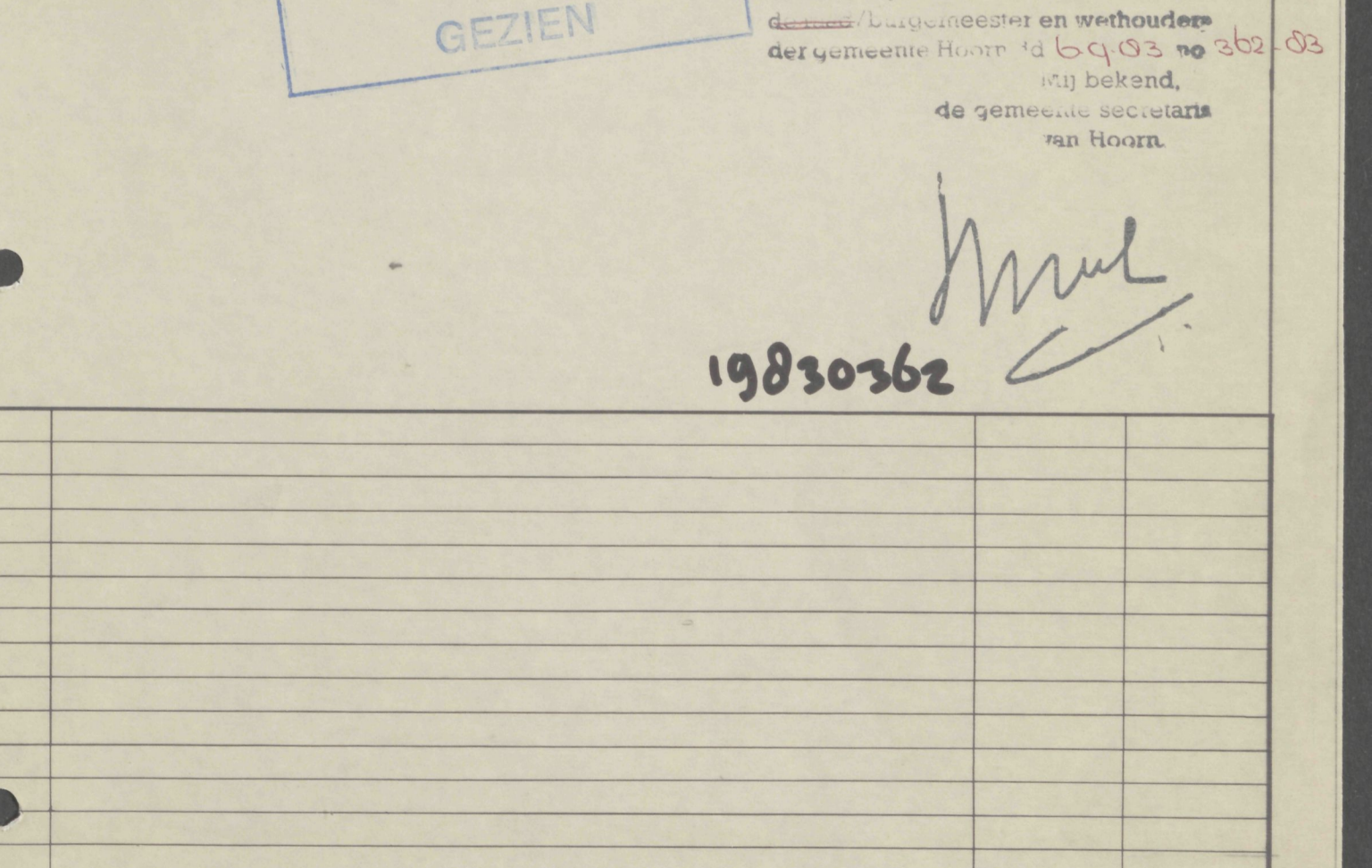
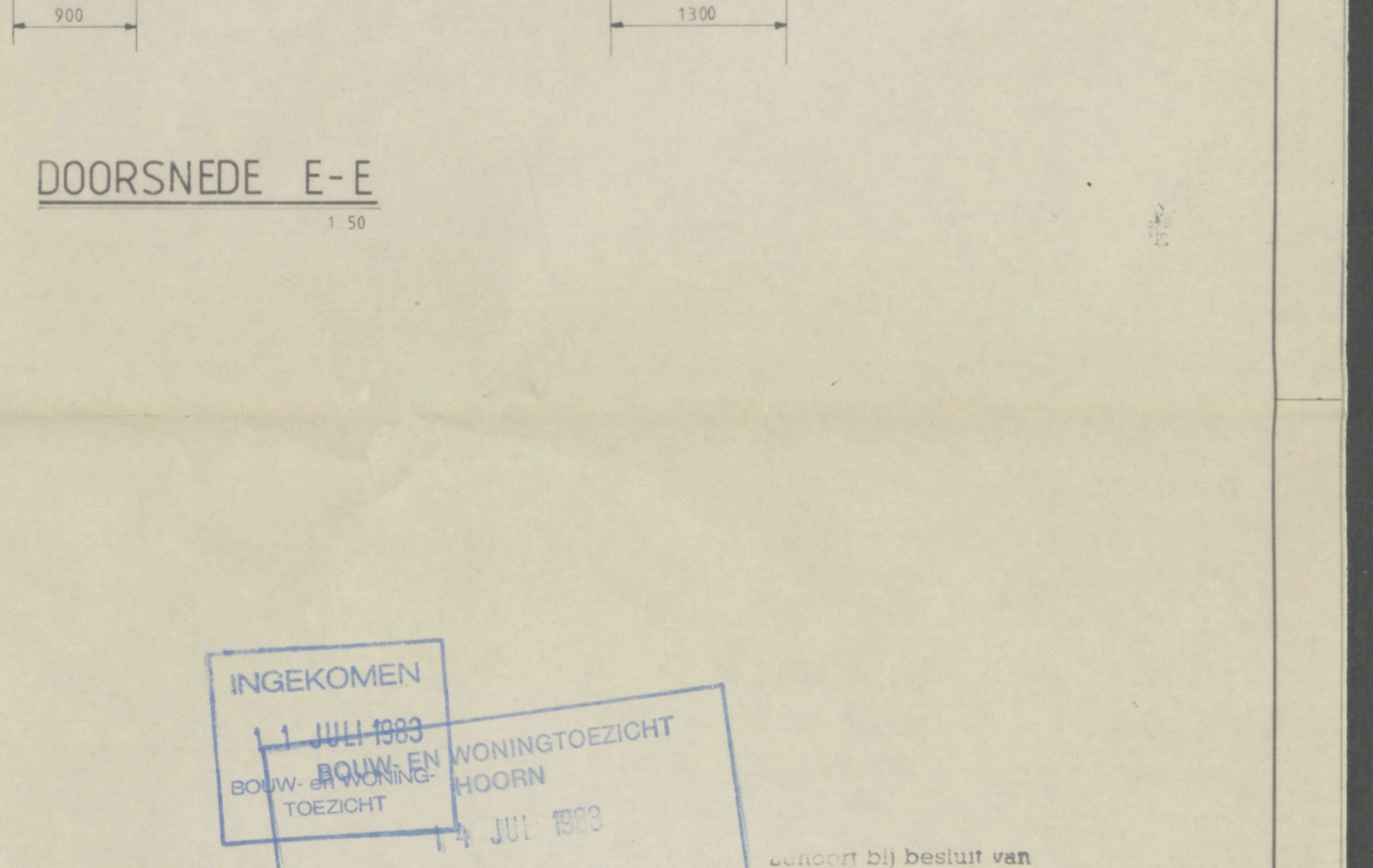
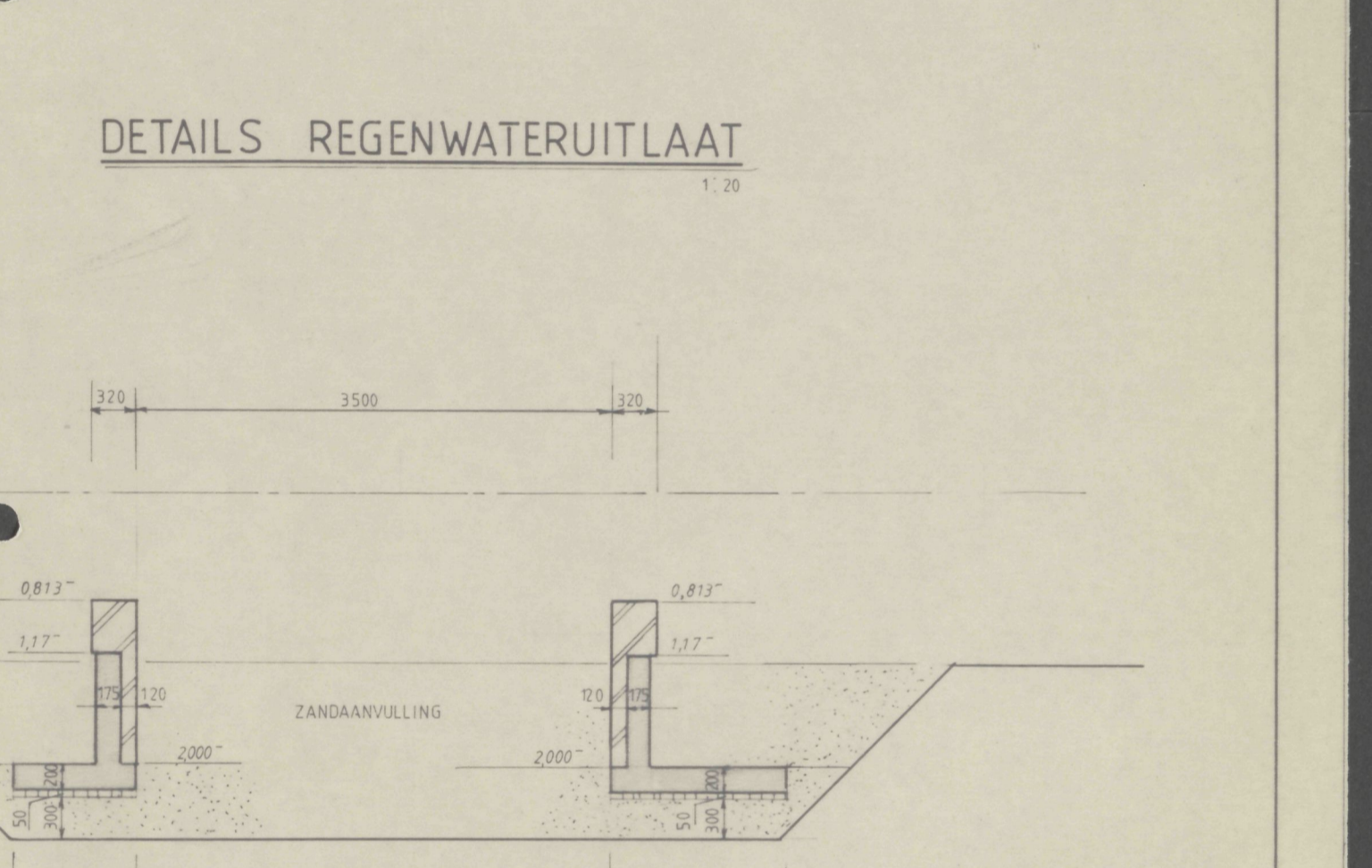
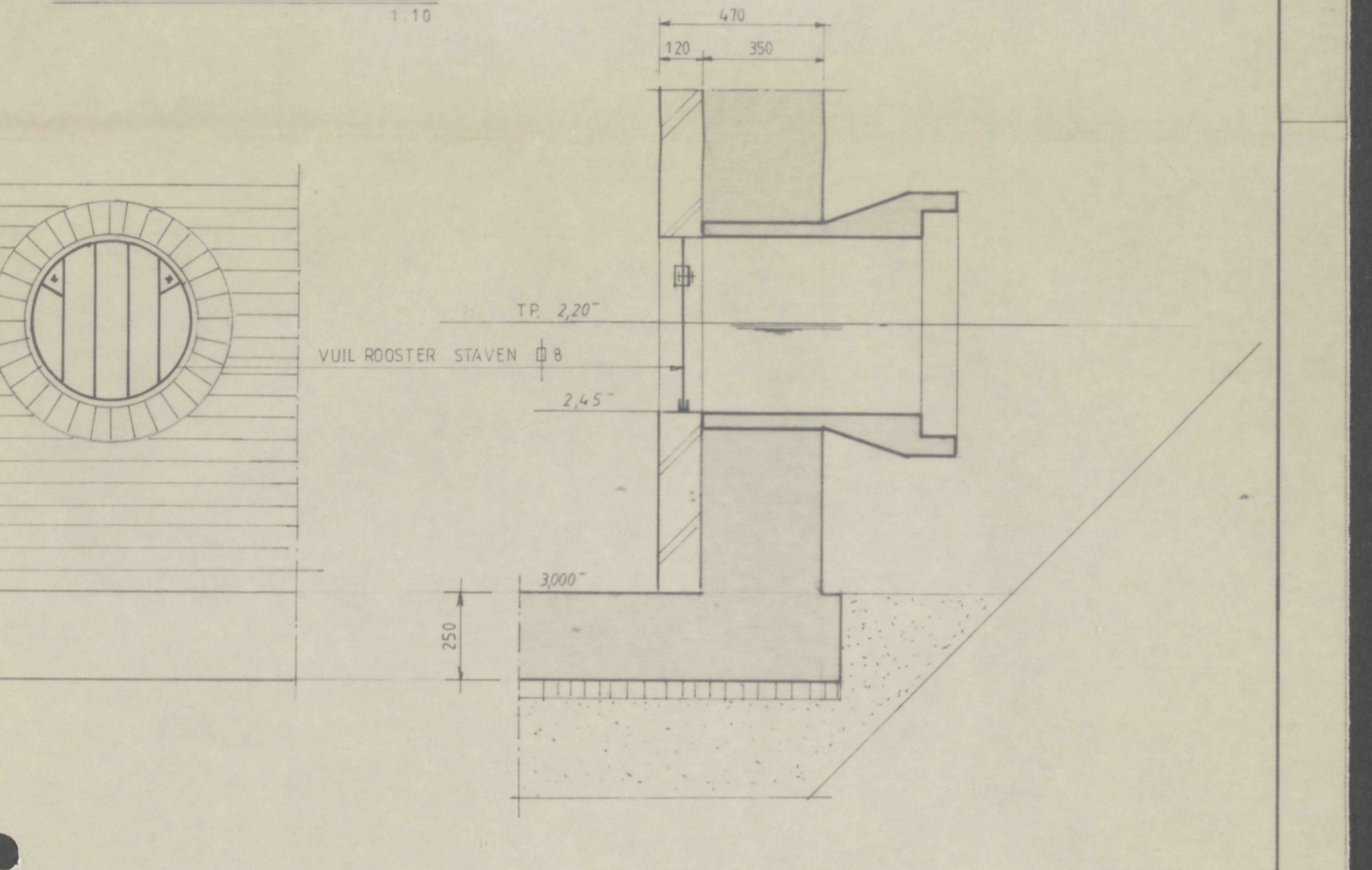
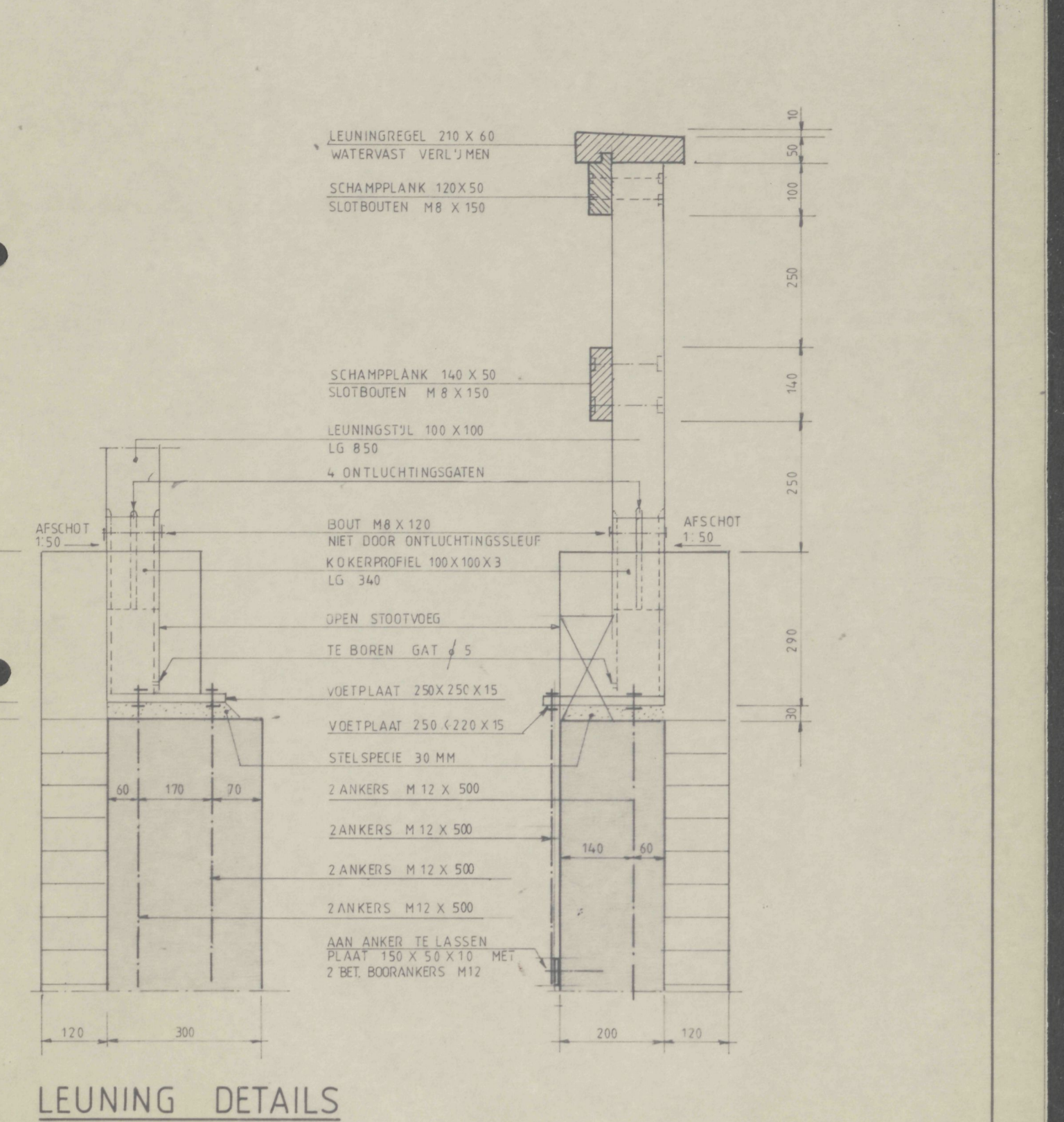
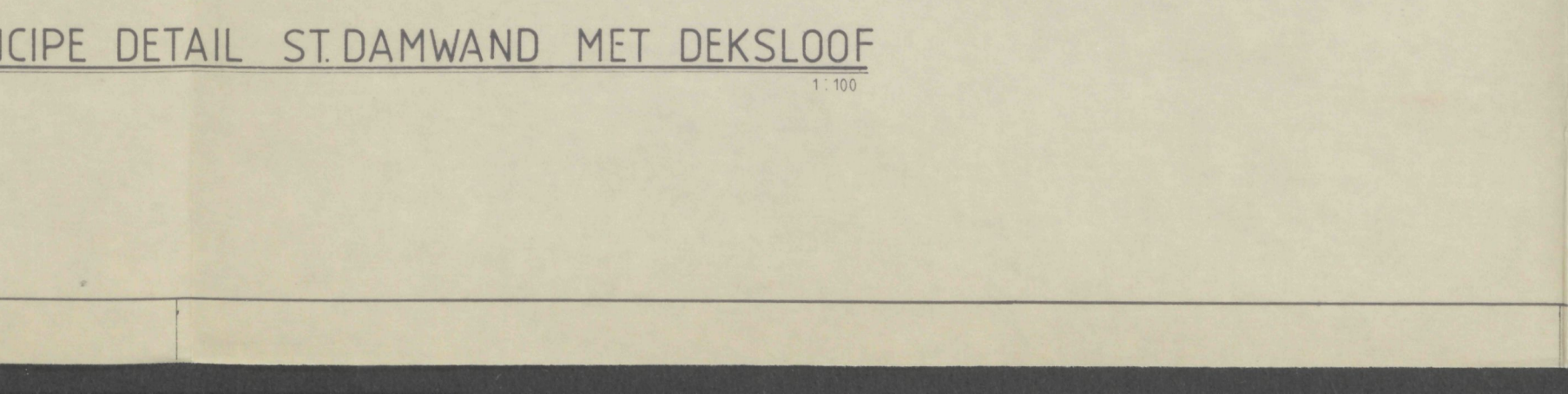
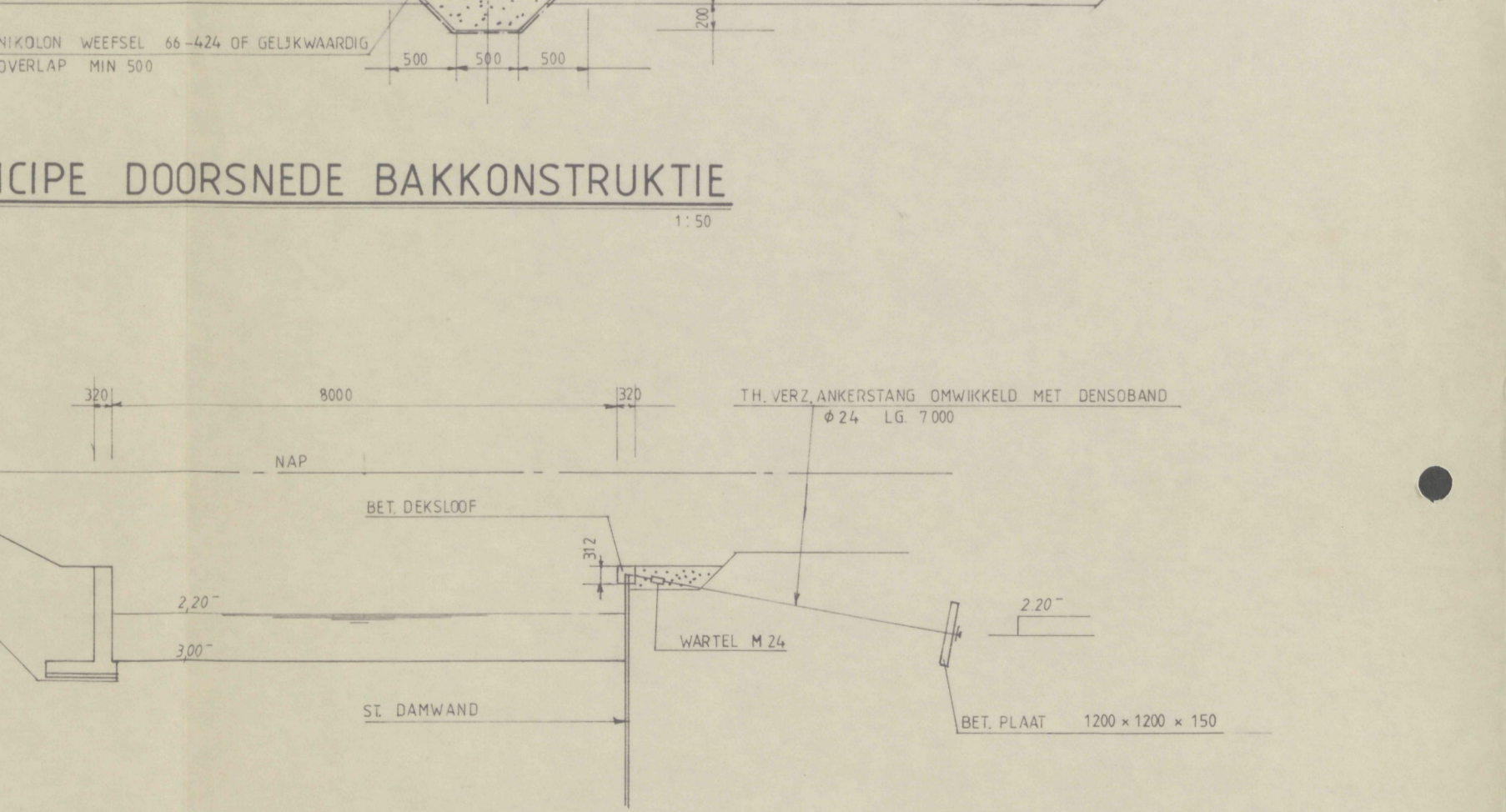
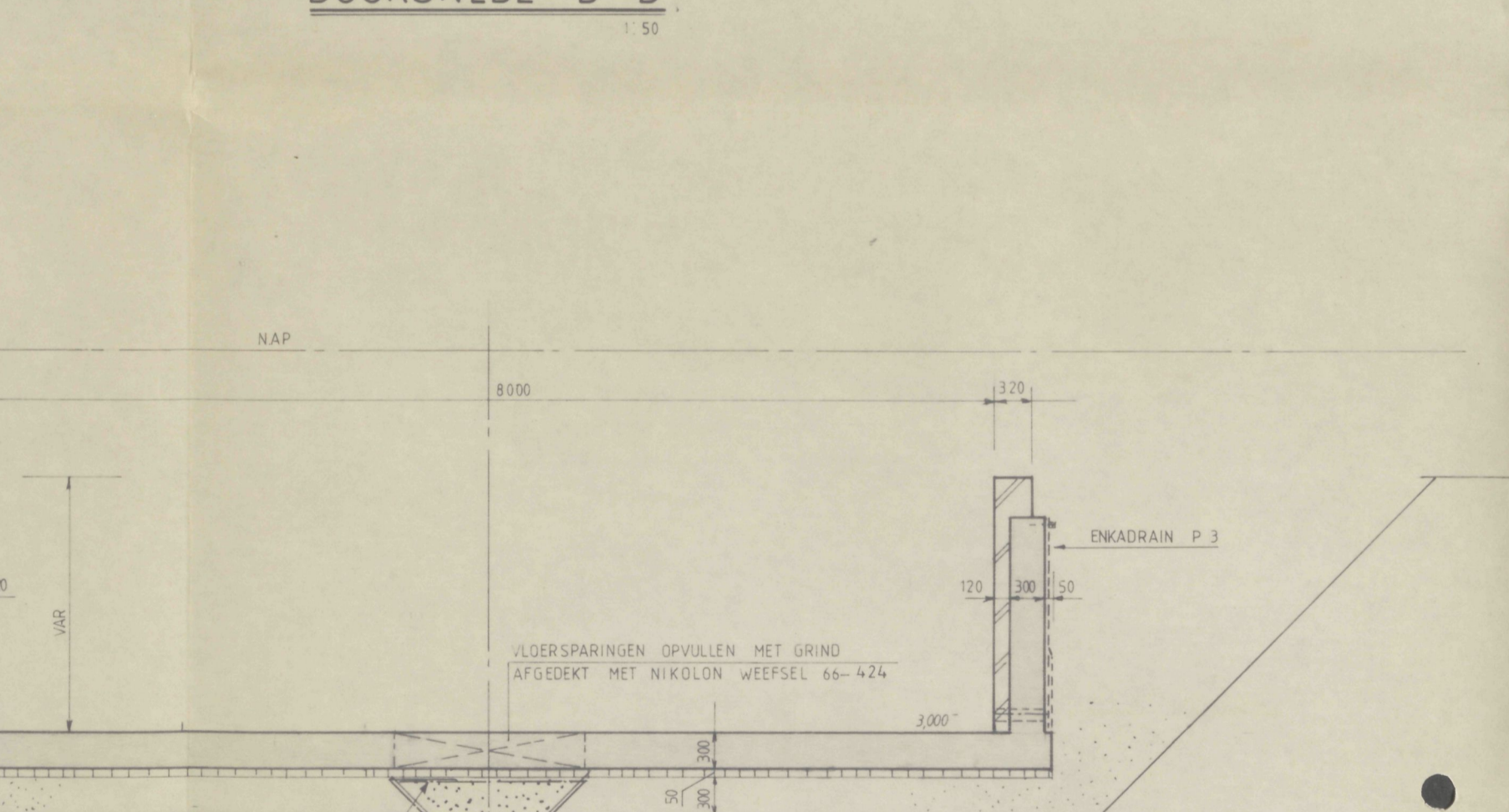
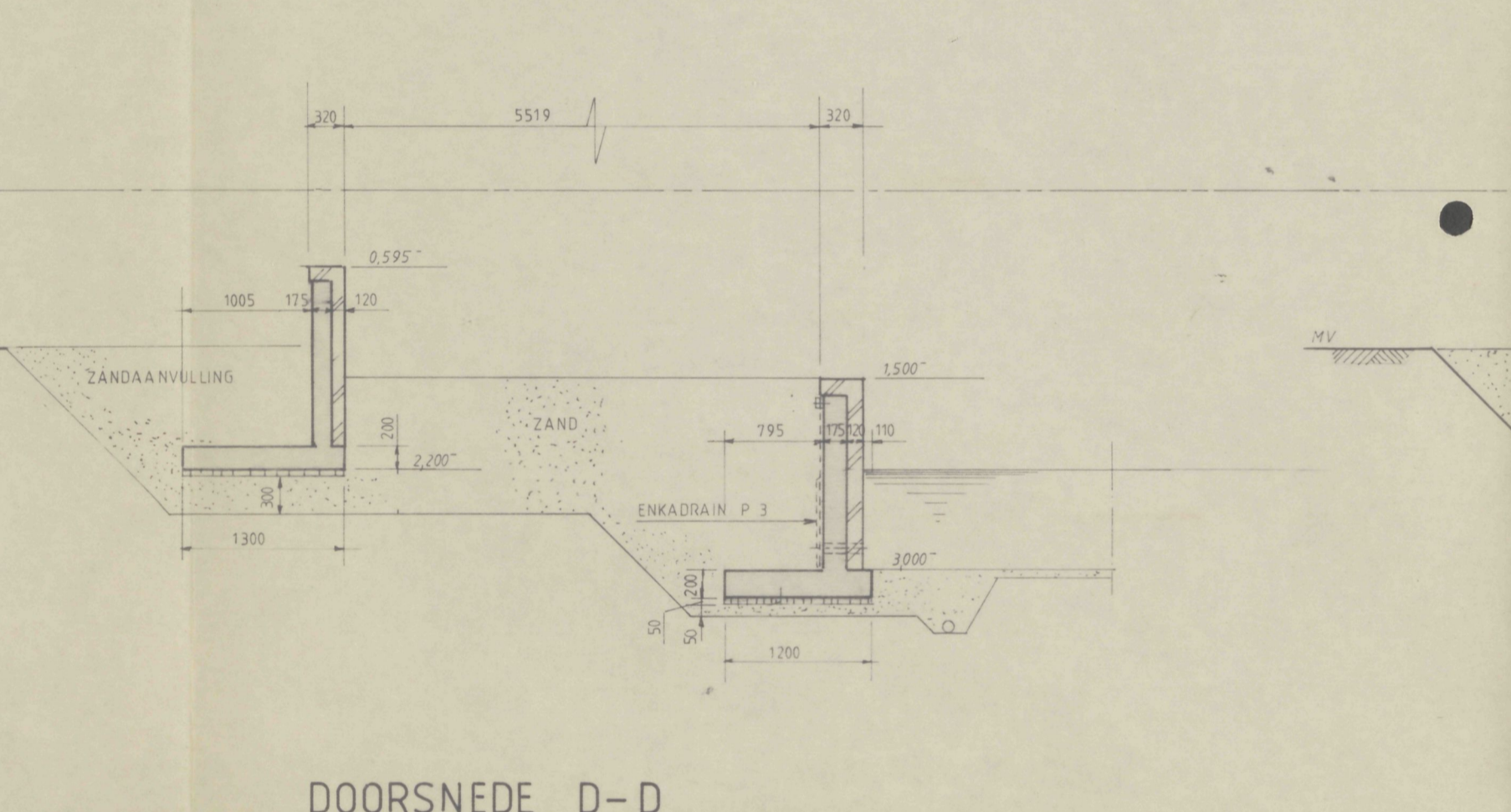
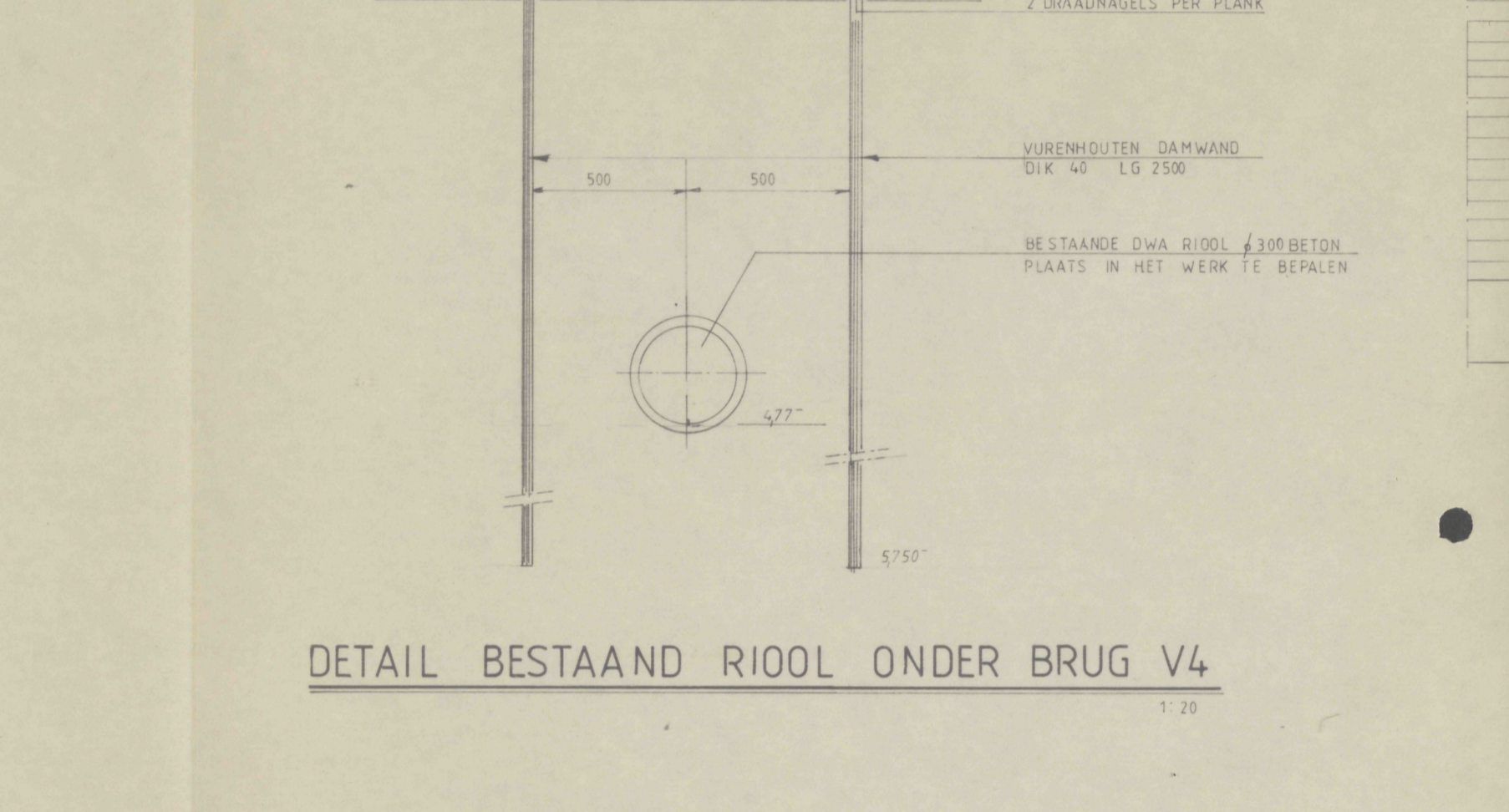
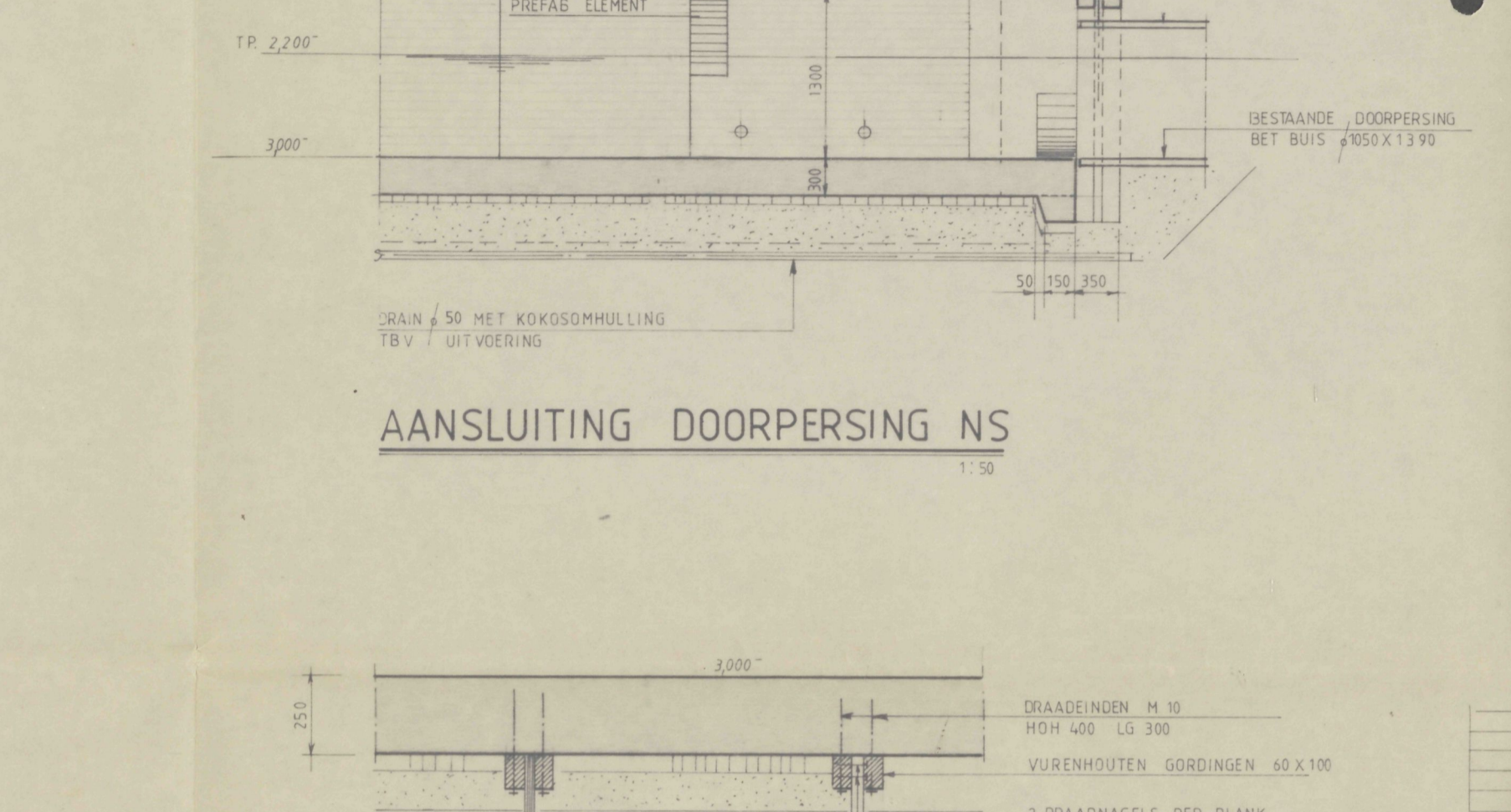
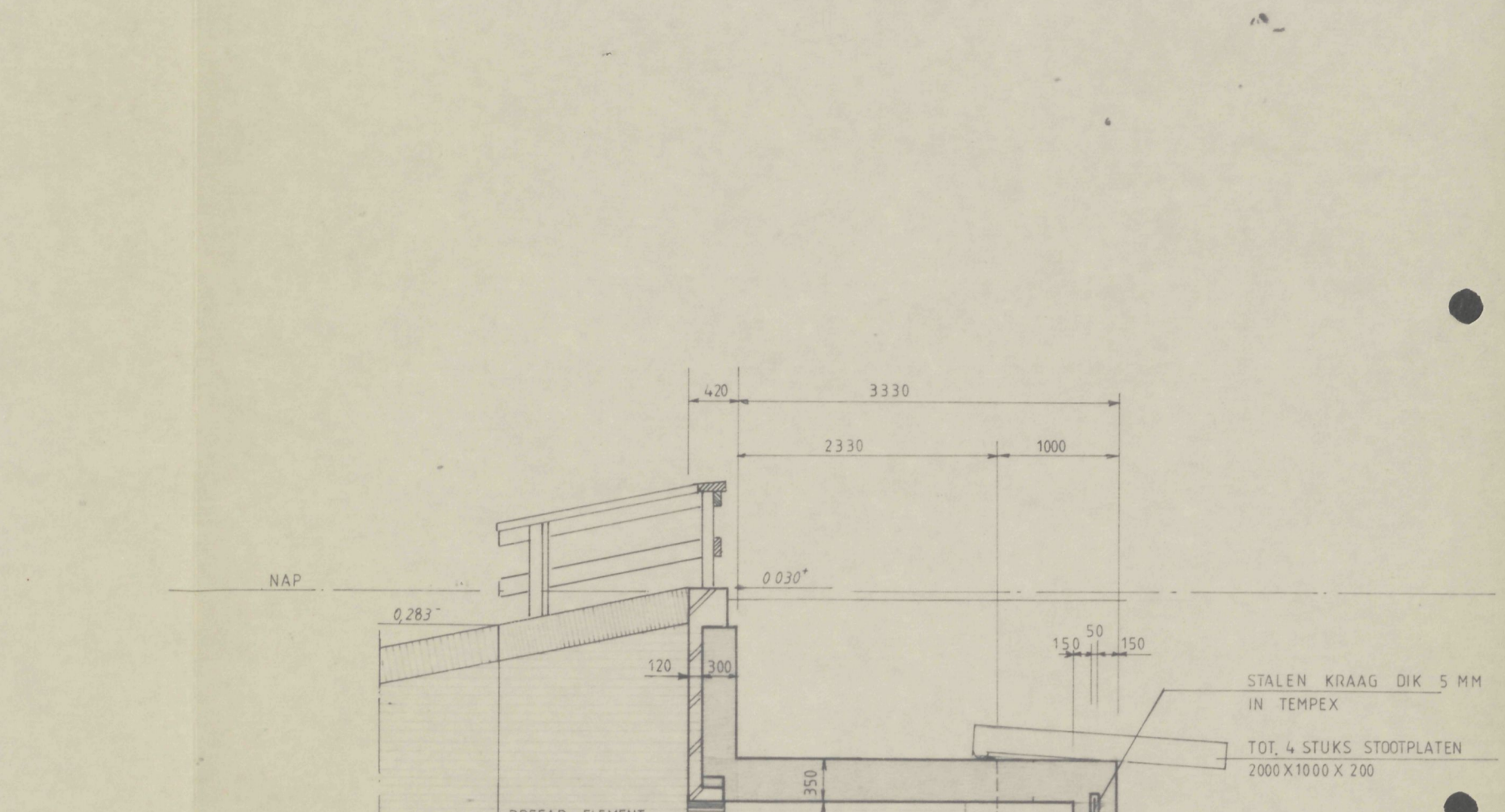
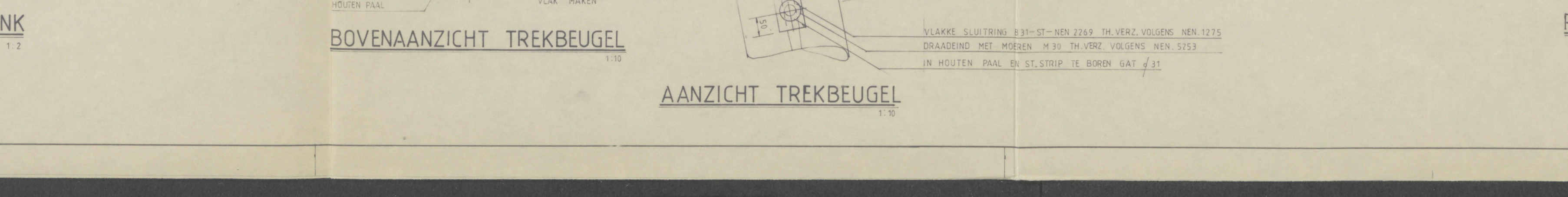
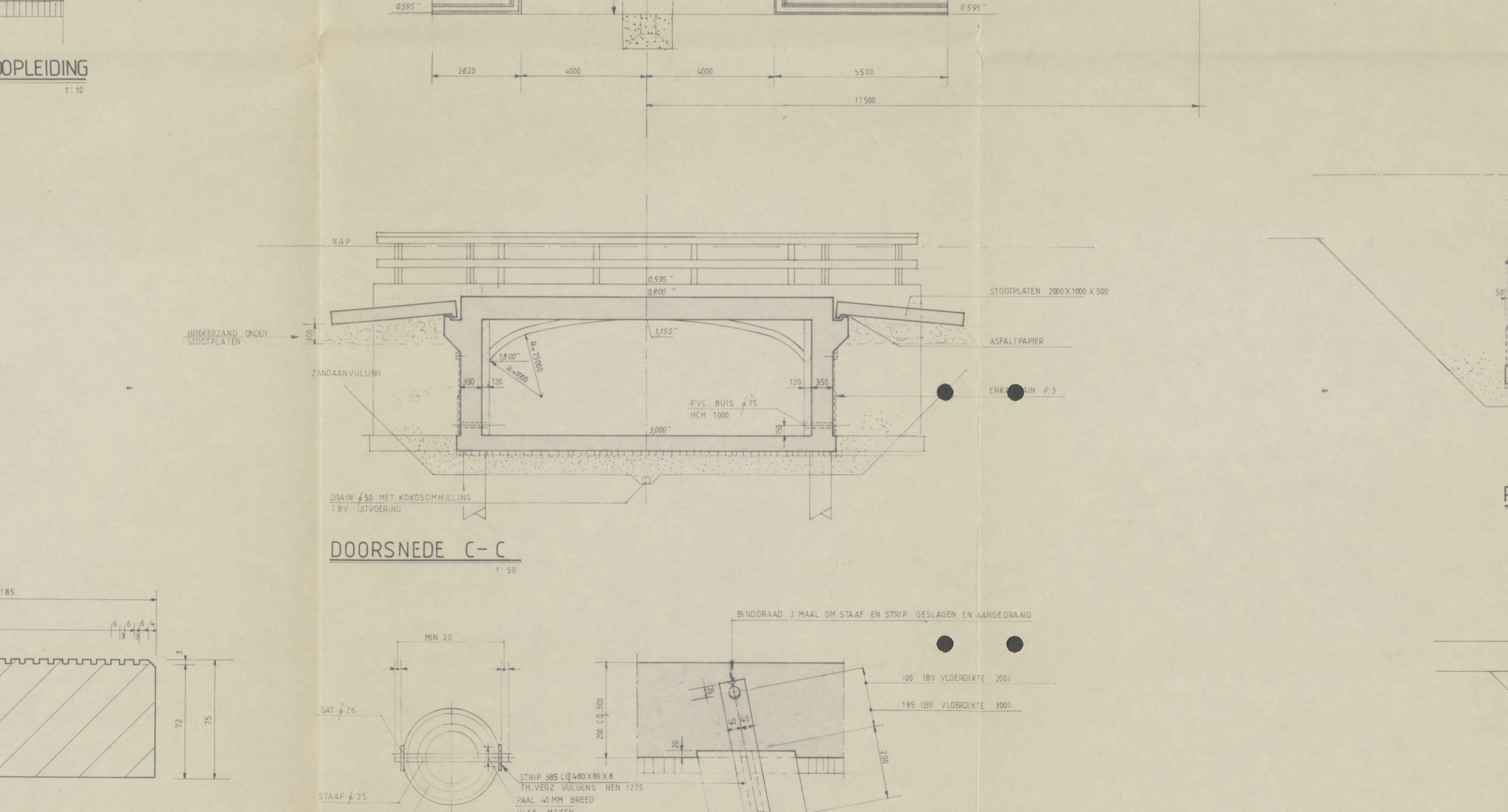
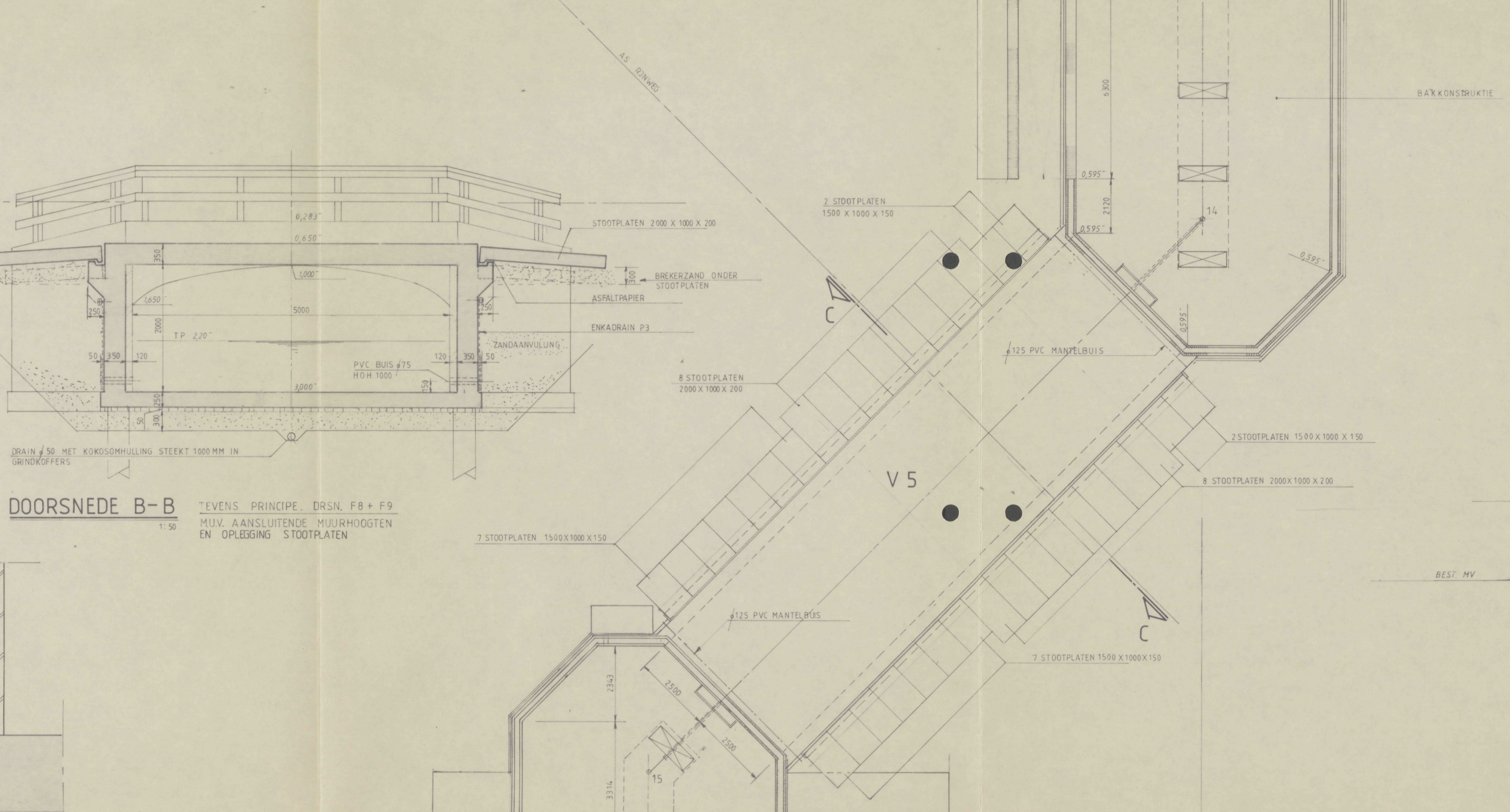
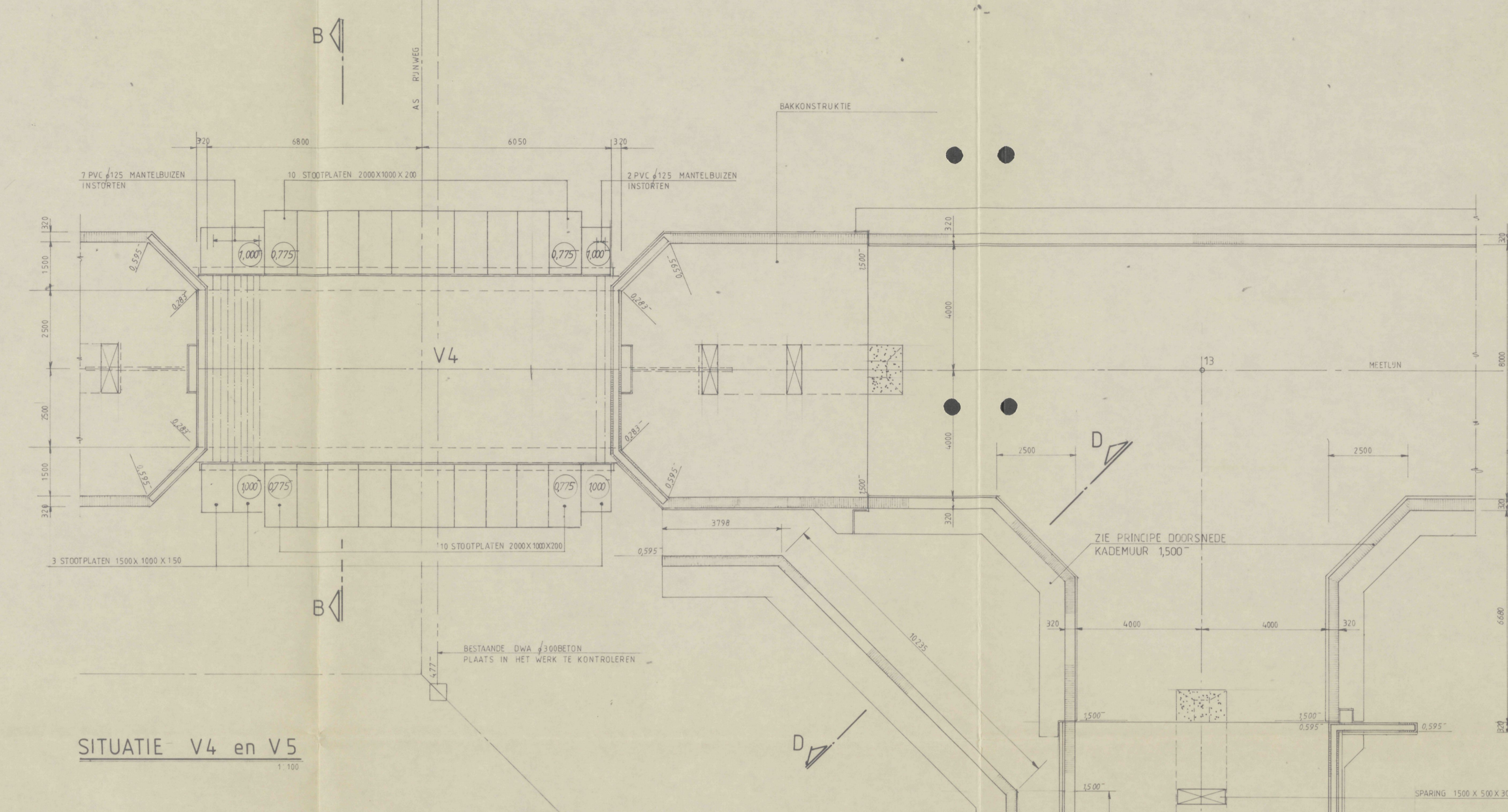
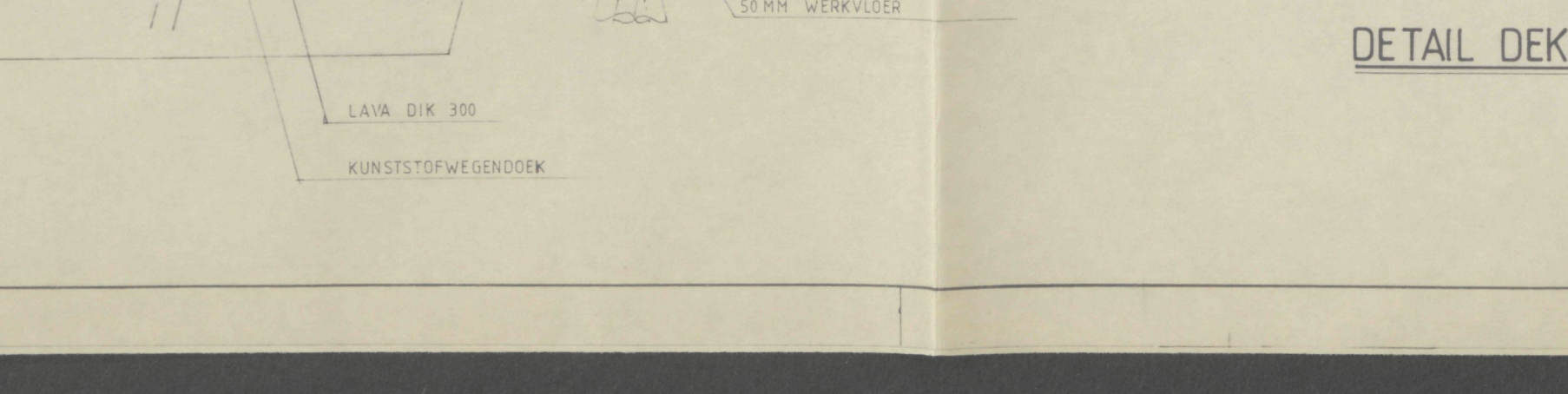
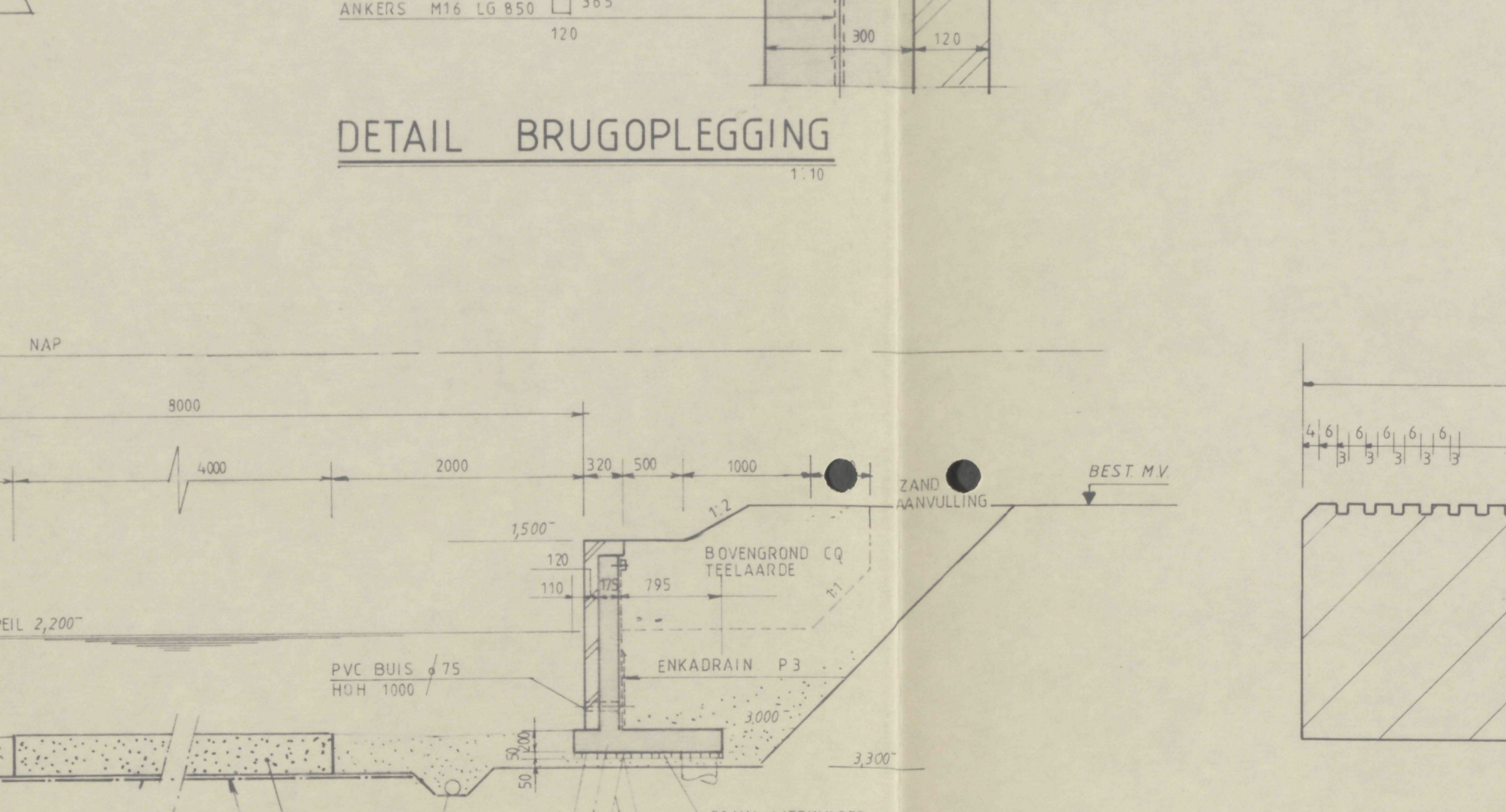
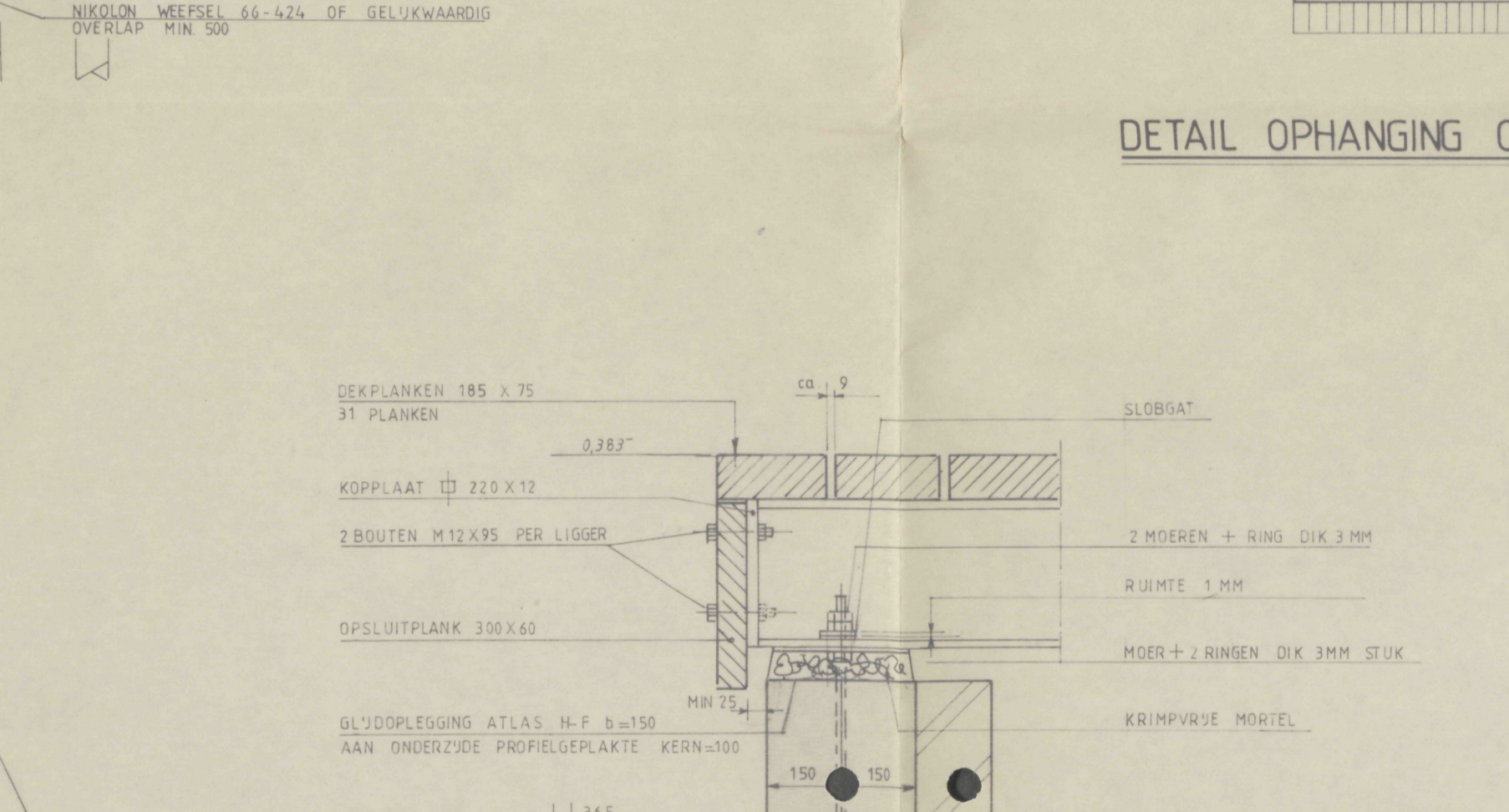
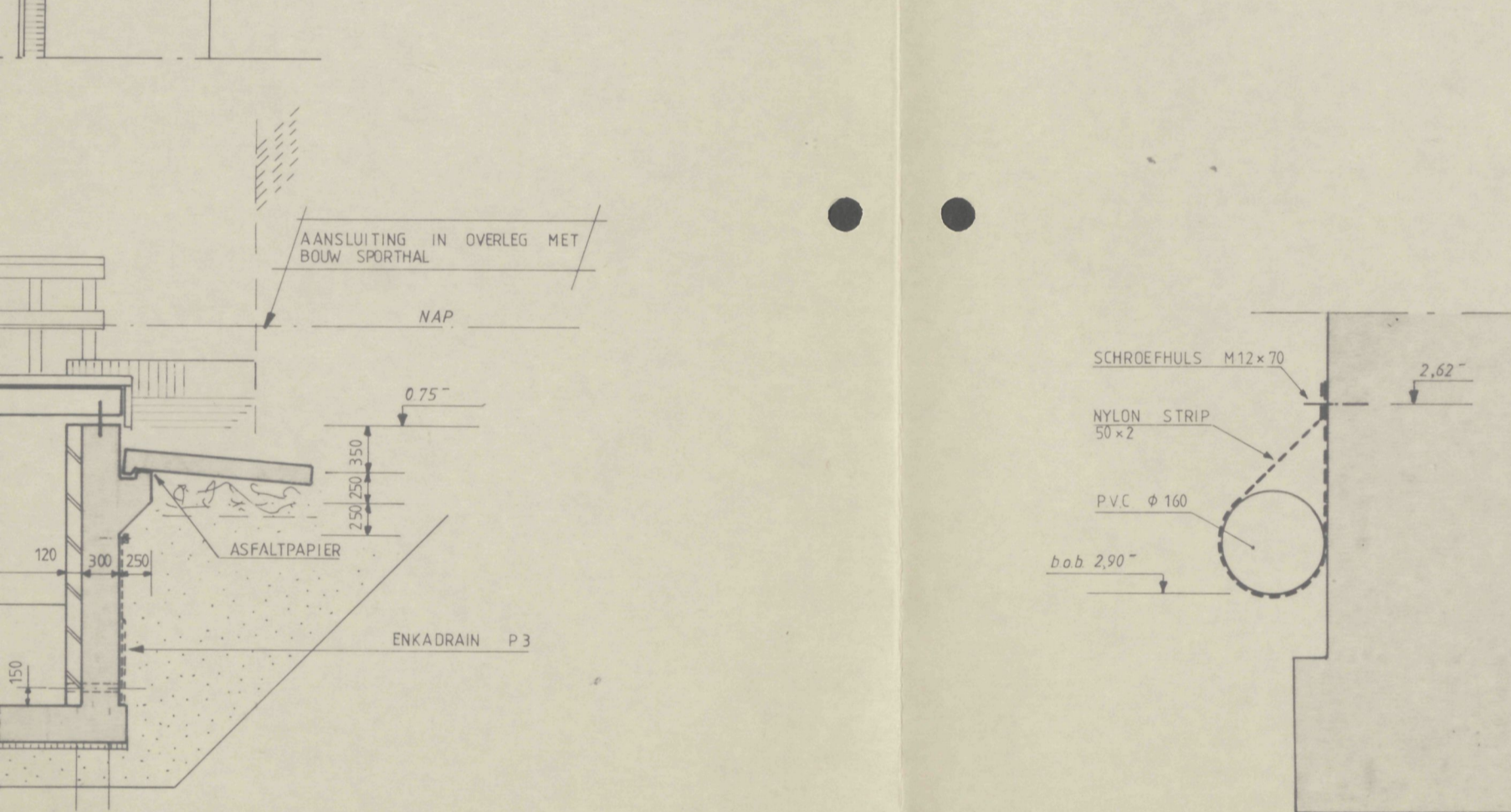
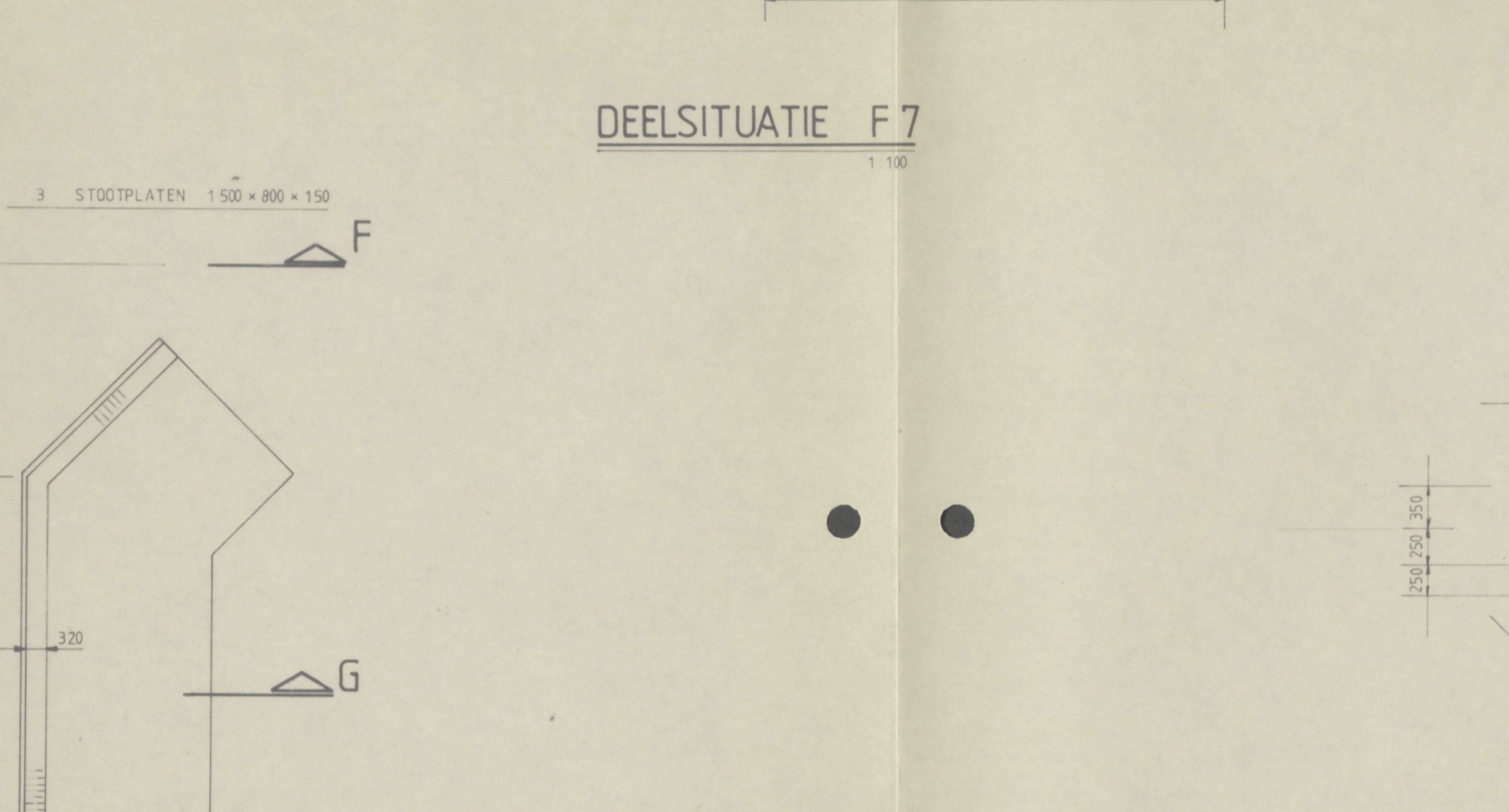
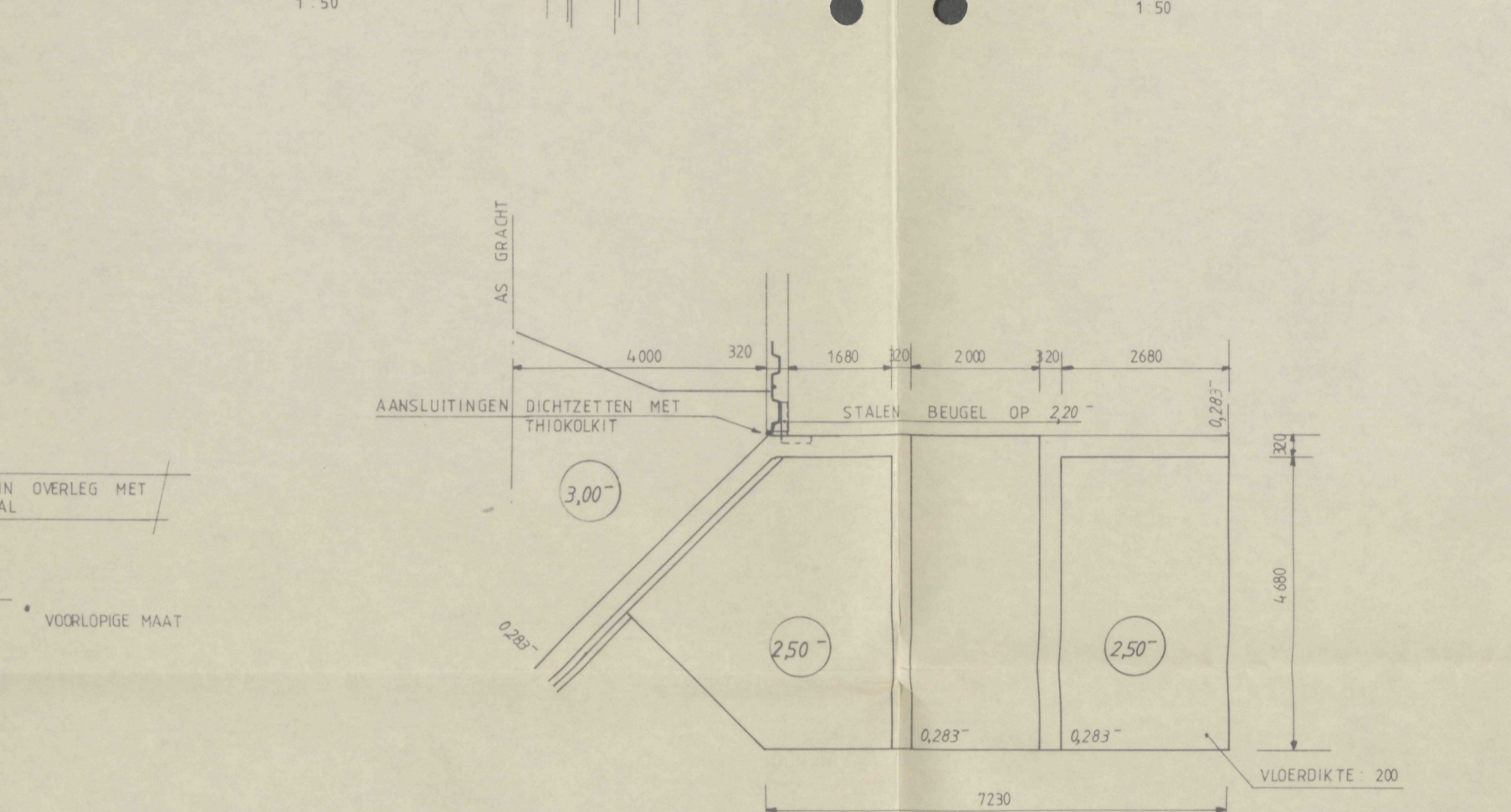
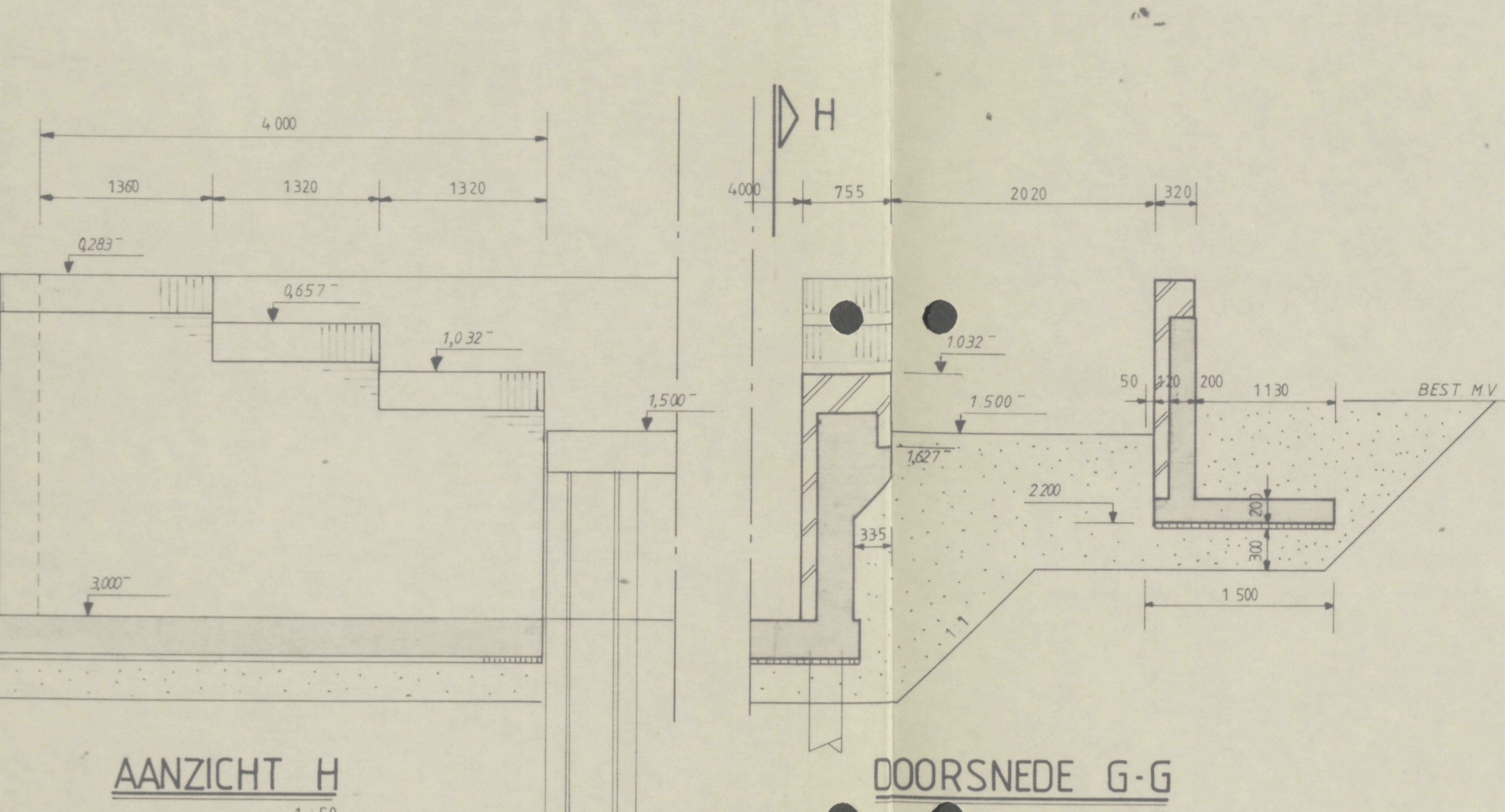

INGEKOMEN  
1 JUL 1983  
BOUW AFWERKEN  
TOEGELIJD  
GEZIEN

19830362

NO. WIJZIGING						DATUM						NAAM											
OPDRACHTGEVER: GEMEENTE HOORN												PROJECT: KADEMUREN KERSENBOOGERG ZUID											
ONDERDEEL: DOORSNEDEN EN DETAILS												INDIEN NIEUW OVERNEMING											
DATUM		NAAM		DATUM		NAAM		DATUM		NAAM		DATUM		NAAM									
GET 010183		T. C. G.		GEK. 010183		Q. A. M.		GEZ.															
FORMAAT: KANTOOR HOORN												SCHAAK: 1:50											
BREEDTE: 1:50												1:25											
1921 KA. HOORN, TEL. 02290-10041												4777 2 0											